

Tegramin-25/-30

Instruction Manual

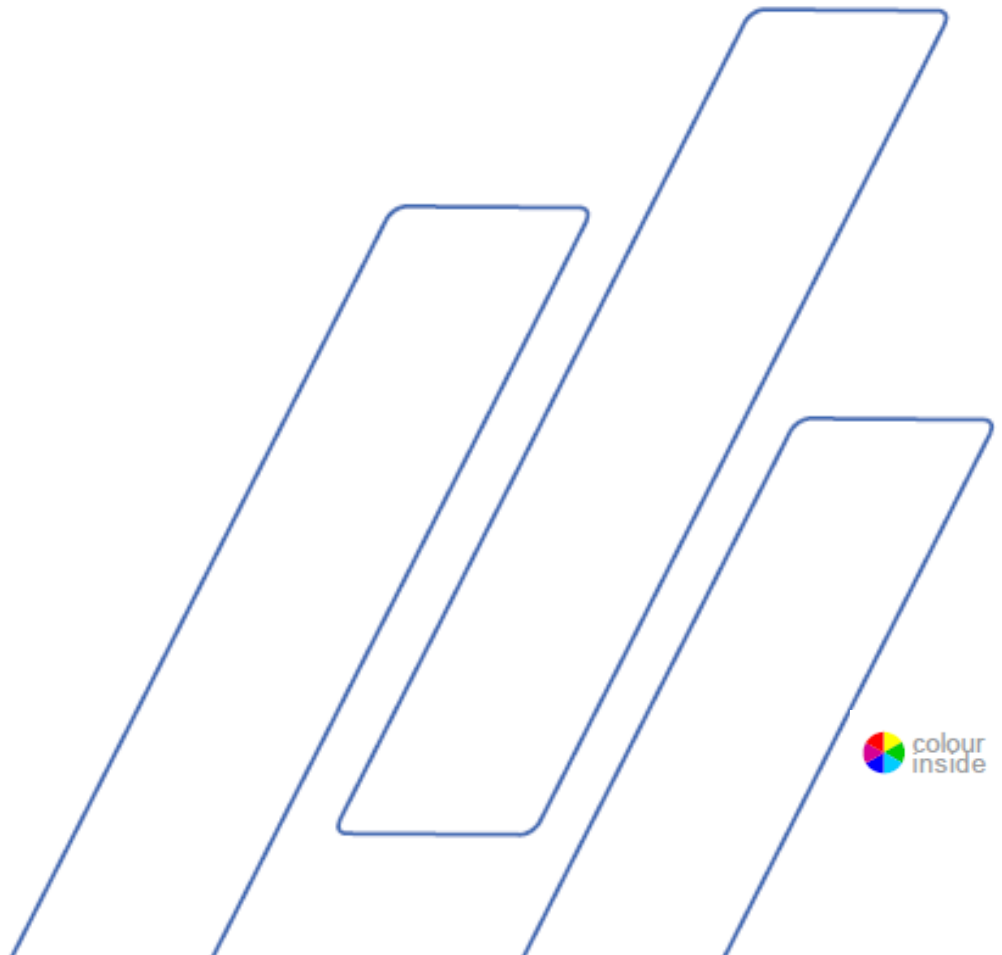

Table of Contents	Page
Intended use	3
Safety Precaution Sheet.....	5
User's Guide	9
Reference Guide	68
Preinstallation checklist.....	90
Contents of the Declaration of Conformity	98

Intended use

Tegramin-25/-30 and Tegramin-25/-30 with Cover

For professional semi-automatic or manual materialographic preparation (grinding or polishing) of materials for further materialographic inspection and only to be operated by skilled/trained personnel. The machine is only designed to be used with Struers consumables specially designed for this purpose and this type of machine.

The machine is for use in a professional working environment (e.g. a materialographic laboratory).

Tegramin-25/-30 with Safety cover

For professional semi-automatic materialographic preparation (grinding or polishing) of materials for further materialographic inspection and only to be operated by skilled/trained personnel. The machine is only designed to be used with Struers consumables specially designed for this purpose and this type of machine.

The machine is for use in a professional working environment (e.g. a materialographic laboratory).

Do not use the machine for:

Preparation (grinding or polishing) of materials other than solid materials suitable for materialographic studies. In particular, the machine must not be used for any type of explosive and/or flammable material, or materials which are not stable during machining, heating or pressure.

Models:

Tegramin-25/-30
Tegramin-25/-30 with Cover
Tegramin-25/-30 with Safety cover



NOTE:

READ the instruction manual carefully before use.
Keep a copy of the manual in an easy-to-access place for future reference.

Always state *Serial No* and *Voltage/frequency* if you have technical questions or when ordering spare parts. You will find the *Serial No.* and *Voltage* on the type plate of the machine itself. We may also need the *Date* and *Article No* of the manual. This information is found on the front cover.

The following restrictions should be observed, as violation of the restrictions may cause cancellation of Struers legal obligations:
Instruction Manuals: Struers Instruction Manual may only be used in connection with Struers equipment covered by the Instruction Manual.

Struers assumes no responsibility for errors in the manual text/illustrations. The information in this manual is subject to changes without notice. The manual may mention accessories or parts not included in the present version of the equipment.

Original instructions. The contents of this manual are the property of Struers. Reproduction of any part of this manual without the written permission of Struers is not allowed.

All rights reserved. © Struers 2018.

Struers
Pederstrupvej 84
DK-2750 Ballerup
Denmark
Telephone +45 44 600 800
Fax +45 44 600 801



Tegramin-25/-30 Safety Precaution Sheet

Read carefully before use

1. Ignoring this information and mishandling of the equipment can lead to severe bodily injuries and material damage.
2. The machine must be installed in compliance with local safety regulations. All functions on the machine and any connected equipment must be in working order.
3. The operator(s) must read the Safety and User's Guide sections of this manual and the relevant sections of the manuals for any connected equipment and accessories.
The operator(s) must read the Instructions for Use and, where applicable, Safety Data Sheets for the applied consumables. Keep a copy of the manual in an easy-to-access place for future reference.
4. This machine is to be operated and maintained by skilled/trained personnel only.
5. The machine must always be used with the Splash guard.
6. The machine must be placed on a safe and stable table with an adequate working height and which is able to carry the machine and supplementary accessories and consumables.
7. Operators should ensure that the actual voltage corresponds to the voltage on the rear of the machine. The machine must be earthed. Follow the local regulations. Always turn the power off and remove the plug or the cable before opening the machine or installing additional components.
8. Connect only to cold water tap. Make sure that the water connections are leak-proof and that the water outlet is working.
9. Struers recommend that the mains water supply is shut off or disconnected if the machine is to be left unattended.
10. Consumables: only use consumables specifically developed for use with this type of materialographic machine.
Alcohol based consumables: follow the current safety rules for handling, mixing, filling, emptying and disposal of the alcohol-based liquids.
11. Keep clear of the rotating disc and the specimen mover during operation. While grinding or polishing manually, be careful not to touch the grinding disc. Do not attempt to collect a specimen from the tray while the disc is running. (Models without cover/ safety cover).
12. Wear suitable gloves to protect fingers from abrasives and warm specimens.
13. Do not touch the mover head, specimen holder or mover plate when moving them downwards.

- 14.** When working at machines with rotating parts care must be taken that clothes and/or hair cannot be caught by the rotating parts. Appropriate safety clothing must be used.
- 15.** If you observe malfunctions or hear unusual noises - stop the machine and call technical service.
- 16.** The machine must be disconnected from the mains prior to any service.
Wait 5 minutes until residual potential on the capacitors is discharged.
- 17.** Do not cycle mains power more than once every three minutes. Damage to the drive will result.
- 18.** In case of fire, alert bystanders, the fire brigade and cut power. Use a powder fire extinguisher. Do not use water.

The equipment should only be used for its intended use and as detailed in the Instruction Manual.

The equipment is designed for use with consumables supplied by Struers. If subjected to misuse, improper installation, alteration, neglect, accident or improper repair, Struers will accept no responsibility for damage(s) to the user or the equipment.

Dismantling of any part of the equipment, during maintenance, service or repair, should always be performed by a qualified technician (electromechanical, electronic, mechanical, pneumatic, etc.).

Icons and typography

Struers uses the below icons and typographical conventions. A list of the Safety Messages used in this manual can be found in the chapter on Cautionary Statements in the Reference Guide section of the Instruction Manual.

Icons and Safety Messages



ELECTRICAL HAZARD

indicates an electrical hazard which, if not avoided, will result in death or serious injury.



DANGER

indicates a hazard with a high level of risk which, if not avoided, will result in death or serious injury.



WARNING

indicates a hazard with a medium level of risk which, if not avoided, could result in death or serious injury.



CAUTION

indicates a hazard with a low level of risk which, if not avoided, could result in minor or moderate injury.



CRUSHING HAZARD

indicates a crushing hazard which, if not avoided, could result in minor, moderate or serious injury.



EMERGENCY STOP

General Messages



NOTE:

indicates a risk of damage to property, or the need to proceed with special care.



HINT:

indicates additional information and tips.

Colour Inside Logo



The 'colour inside' logo on the cover page of this Instruction Manual indicates that it contains colours which are considered to be useful for the correct understanding of its contents. Users should therefore print this document using a colour printer.

Typographic conventions

Bold type	indicates button labels or menu options in software programs
<i>Italic type</i>	indicates product names, items in software programs or figure titles
■ Bullets	indicates a necessary work step

User's Guide

Table of Contents	Page
1. Getting Started	
Device Description	11
Checking the Contents	12
Unpacking Tegramin	12
Placing Tegramin	13
Getting Acquainted with Tegramin.....	14
Rear of Tegramin	15
Supplying Water.....	17
Connection to Water	17
Mains	17
Connection to Water Outlet.....	17
Adjusting the Water Flow	18
Connecting a Recirculation Cooling Unit	19
Connecting the Water Inlet.....	19
Connecting the Water Outlet	19
Connecting the Communication Cable	20
Installing the Shift Valve	20
Compressed Air Connections.....	21
Emptying the Water / Oil Filter.....	21
External Exhaust.....	21
Tegramin with Cover / safety Cover	21
Supplying Power	22
Single-phase Supply	22
2-phase Supply	22
Connection to the Machine.....	22
Mounting the Dosing Modules	23
Mount the Preparation Disc	24
Noise.....	24
Vibration.....	25
2. Basic Operation	
Front Panel	26
Front Panel Controls	27
Reading the Display	28
Manoeuvring in the Menu Structure	29
Acoustic Signals.....	29
Software Settings	30
Changing the Language	32
Editing Numeric Values	34
Editing Alphanumeric Values	35
Operation Mode	36
Changing Operation Mode	36
New Pass Code	37
Bottle Configuration.....	38

Preparation Process Setup.....	41
Selecting a Preparation Mode	41
Selecting a Preparation Method	43
Creating a Preparation Method	44
Modifying an existing preparation method	47
Locking a Preparation Method.....	48
Unlocking a Preparation Method	49
Setting Dosing Levels	49
Starting the Preparation Process.....	50
Stopping the Process	50
Spin Function	50
Inserting Specimen Holders or Specimen Mover Plates	51
Inserting a Specimen Holder	51
Inserting a Specimen Mover Plate.....	51
Lowering the Specimen Mover Head.....	51
Adjusting the Horizontal Position of the Specimen Holder / Mover Plate.....	52
Placing the Specimens in a Mover Plate	52
Recommendations for Grinding Single Specimens.....	52
Manual Preparation.....	53

3. Maintenance

Daily Service	54
Weekly Service	54
Cleaning of Tubes	54
Cleaning the Bowl	55
Cleaning of Specimen Mover Head.....	56
Calibration of Pump Capacity	56
Adjustment of Tube Cleaning Time	58
Changing Tubes.....	59
Adjusting the Specimen Mover Plate Height.....	61
Reset Functions	62
Reset Methods.....	62
Reset Configuration	62
Yearly.....	63
Testing Safety Devices	63
Checking Cover Springs.....	63
Spare Parts	63

4. Cautionary Statements 64

List of Safety Messages in the Manual	64
---	----

5. Transport and Storage..... 66

6. Disposal 67

1. Getting Started

Device Description

Tegramin-25/-30 is a semi-automatic or manual machine for materialographic preparation (grinding/polishing). Tegramin-25 for 250 mm diameter preparation disc and Tegramin-30 for 300 mm diameter preparation disc.

The operator selects the preparation method, the grinding/polishing surface and the cooling fluid/abrasive suspension to be automatically applied.

Semi-automatic preparation starts by clamping the specimens in the specimen holder or by placing them in the specimen mover plate.

Manual preparation (not available for the models with safety cover) may be selected for special applications. The specimens are hand-held during the preparation.

For the semi-automatic process, the operator decides which holding device should be used:

With a specimen holder, which is a fixture that secures the specimens.

With the specimen mover plate, pressurized feet from the mover head keep the specimens in place.

The operator starts the machine manually by pressing the start button.

The machine stops automatically, and the operator cleans the specimens before the next preparation step or inspection.

The machine must always be used with the splash guard in place.

We recommend connecting the machine to an exhaust system to remove fumes from the working area.

For models with cover, the machine stops if the cover is opened, unless *Allow operation with cover open* is selected.

For models with safety cover, the machine stops if the cover is opened.

If the emergency stop is activated, the power to all moving parts is cut.

Tegramin-25/-30 models:

- Without cover
- With cover
- With safety cover

Checking the Contents

Tegramin-25/ -30

In the packing box you should find the following parts:

- | | | |
|---------|----------------------------|--|
| 1 | Tegramin-25 or Tegramin-30 | |
| Models: | Without cover: | Dummy plug mounted
(see page16) |
| | With cover: | Cover mounted |
| | With safety cover: | Safety cover mounted
(see label on cover) |
-
- 1 Splash guard
 - 2 Mains cables
 - 1 Water inlet hose 19 mm / 3/4" dia. (2 m)
 - 1 Filter gasket
 - 1 Reduction ring with gasket 3/4" to 1/2"
 - 1 Water outlet hose 40 mm / 1 1/2" dia. (1.5 m)
 - 2 Hose clamps
 - 1 Connection piece for compressed air (1/8" to 6 mm dia. tube)
 - 1 Allen key with cross handle 6x150 mm
 - 1 Instruction Manual Set

Unpacking Tegramin



NOTE:

Always lift Tegramin from underneath the machine.

A crane and 2 lifting straps¹ are required to lift Tegramin off the shipment pallet.

- Before lifting Tegramin into position:
- Remove the screws around the base of the packing crate and lift the entire upper part of the crate.
- Remove the metal brackets securing Tegramin to the pallet (a 4 mm Allen key is required to remove the 8 screws that secure the metal brackets).
- Place the two lifting straps under Tegramin.

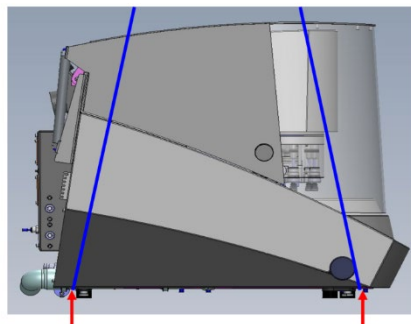

Position straps here.

- Position the straps under Tegramin, so that they are on the outer side of the feet.
- Use straps which are long enough so that they do not place stress on the cover (use straps of approx. 3-3 1/2 m in length).

¹ Straps must be approved of at least twice the weight of the machine.

- A lifting bar is recommended so that the two straps are kept apart below the lifting point.

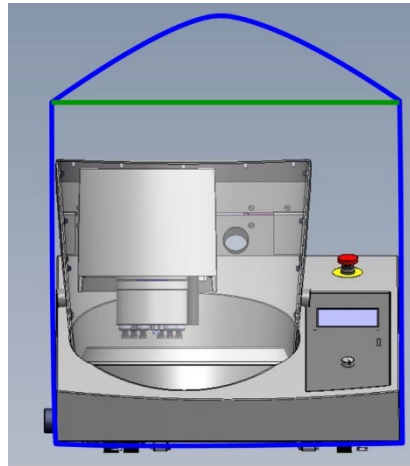

*Tegramin with cover/ Safety cover:
Ensure that the lifting straps are held away from the top cover*

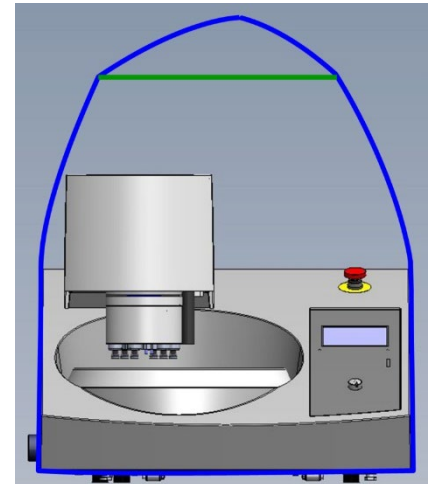

Tegramin without cover:

- Lift Tegramin onto the table.
- Lift the front of Tegramin and carefully move into place using the rollers.



HINT:

Store the packing crate, bolts and brackets for use whenever Tegramin is transported/re-located. Failure to use the original packaging and fittings could cause severe damage to the machine and will void the warranty.

Placing Tegramin

- The machine must be placed on a safe and stable table with an adequate working height and which is able to carry at the machine and supplementary accessories and consumables. Check that the Tegramin is resting securely with all 4 rubber feet on the table.
- The machine must be close to the power supply, water mains and water outlet facilities.
- The machine must be operated in a well-ventilated room or connected to an exhaust system.
- Remove the screw holding the transport lock on the cone shaft.
- Press the black release button and remove the transport lock.

Getting Acquainted with Tegramin

Please familiarise yourself with the location and names of all the Tegramin components:

MAIN SWITCH

The main switch is located on the rear of the machine.



The EMERGENCY STOP is located on the front of the machine. Emergency Stop to stop all movement and the pumps. If connected to tap water, the valve closes.

- Push the red button to Activate.
- Turn the red button clockwise to Release.



WARNING

Do not use the Emergency stop for operational stop of the machine during normal operation.

BEFORE releasing (disengaging) the Emergency stop, investigate the reason for activating the Emergency stop and take any necessary corrective action.



HINT:

The following illustrations are of Tegramin versions without a cover. Installation of Tegramin versions with or without a cover/safety cover will be identical.

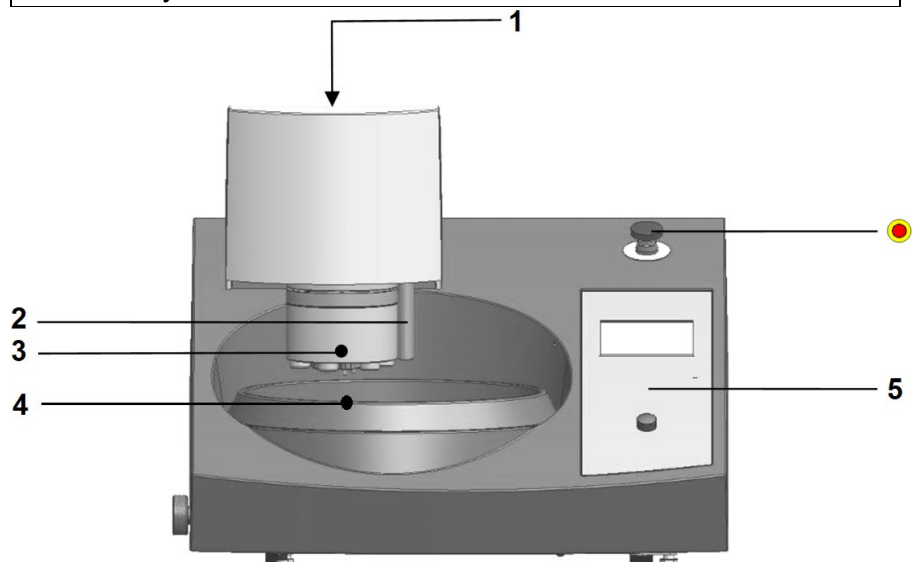

- 1 Adjustment screw for the specimen mover plate height
- 2 Dosing nozzles
- 3 Button for release of specimen holder/ mover plate
- 4 Bowl and Bowl Liner
- 5 Front panel control(s)

Rear of Tegramin

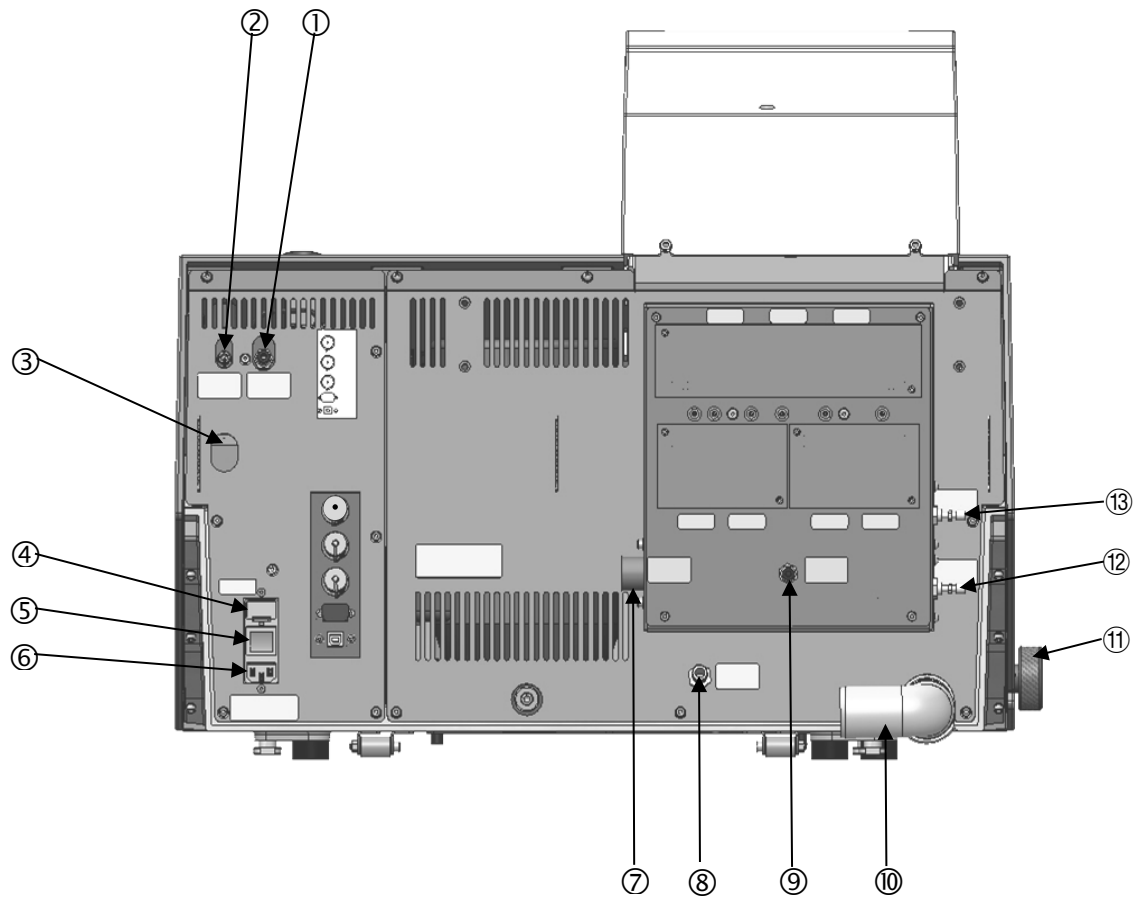

- ① Air outlet for shift valve
- ② Compressed air inlet
- ③ Release outlet valve from water/oil filter for compressed air
- ④ Fuses
- ⑤ Main switch
- ⑥ Mains connection
- ⑦ Water inlet (mains water $\frac{3}{4}$ "
- ⑧ Water inlet (from Recirculation Cooling Unit)
- ⑨ OP-S module, flushing water
- ⑩ Water outlet pipe
- ⑪ Water valve, for wet grinding
- ⑫ Throttle valve, disc cooling
- ⑬ Throttle valve, flushing water for OP

*Tegramin-25/ -30
Instruction Manual*

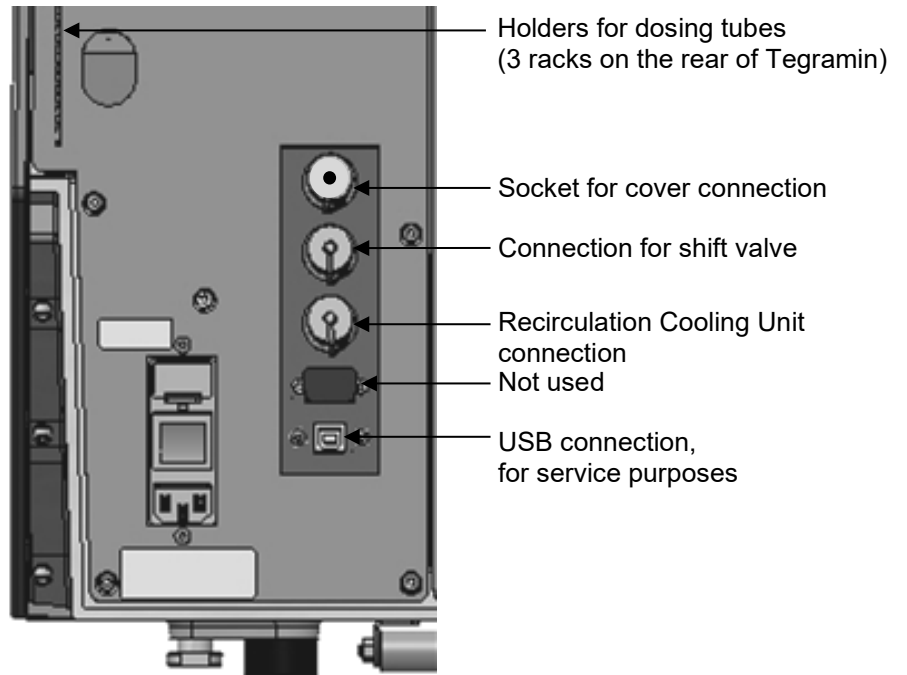

Covers

A standard Cover is available as an optional accessory. Safety covers are not an accessory and are only available for the Tegramin with Safety cover models.

Socket for Cover Connection

Without cover

Dummy plug must be in place for Tegramin to operate, unless Tegramin is equipped with a cover or safety cover.



With cover
With safety cover

Cover is connected to the socket
Safety cover is connected to the socket

Supplying Water

Water for wet grinding is supplied from the water mains or a Recirculation Cooling Unit (instructions on the next page).

Connection to Water Mains



NOTE:

The cold water supply must have a head pressure in the range 1 – 10 bar (14.5 – 145 psi).



HINT:

With new water pipe installations, leave the water to run for a few minutes to flush any debris from the pipe, before connecting to Tegramin.

- Mount the 90° end of the inlet hose onto the water inlet on the rear of Tegramin (see Getting Acquainted with Tegramin):
 - Insert the filter gasket in the coupling nut with the flat side against the pressure hose.
 - Tighten the coupling nut completely.
- Mount the straight end of the inlet hose on the water mains tap for cold water:
 - If required, mount the reduction piece with gasket on the water mains tap and tighten the coupling nut completely.

Connection to Water Outlet

- Mount the outlet hose onto the water outlet pipe. (Lubricate with grease or soap to facilitate insertion.) Use a hose clamp for fastening.
- Lead the other end of the drain hose to the water outlet. Arrange the hose so that it slopes downward towards the drain throughout its length. Shorten the hose, if necessary.



HINT:

Make sure that the drain hose slopes downward towards the drain throughout its length and avoid sharp bends in the drain hose.

Adjusting the Water Flow

The flow of cooling water when grinding can be adjusted using the water valve.

Water flow for disc cooling and flushing after OP can be adjusted using the throttle valves (on the rear of Tegramin).

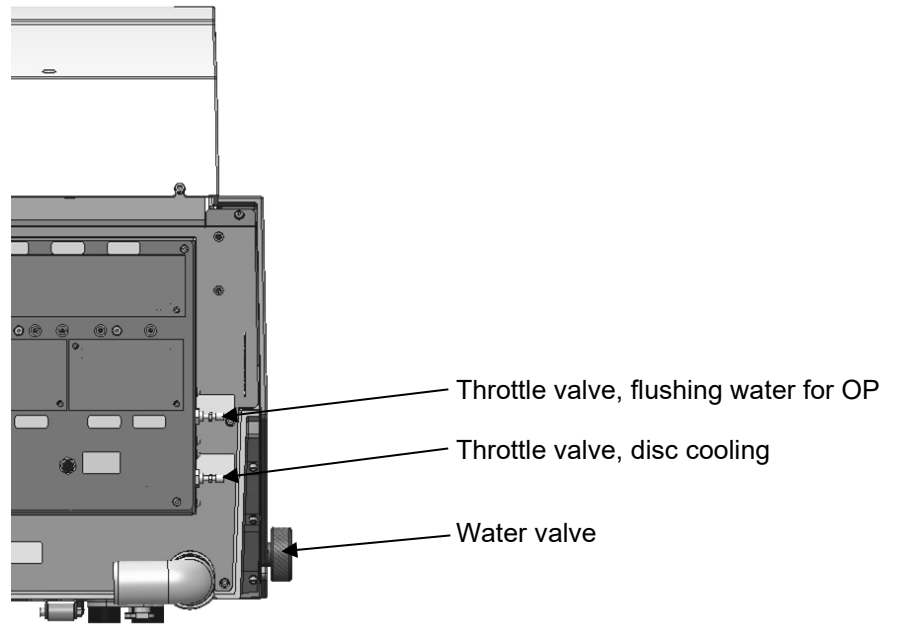

Connecting a Recirculation Cooling Unit

To ensure optimal grinding, Tegramin can be fitted with a Struers Recirculation Cooling Unit.



NOTE:

When connecting Tegramin to both mains water AND the recirculation cooling unit you also must install the shift valve for the drain.

Failure to do this may result in emptying or overflowing the recirculation cooling unit.



NOTE:

Before connecting the cooling unit to the Tegramin, follow the instructions in the Struers Cooling Units Instruction Manual to prepare it for use.



ELECTRICAL HAZARD

- Switch the power off when installing electrical equipment.
- The machine must be earthed (grounded).
- Check that the mains voltage corresponds to the voltage stated on the type plate on the side of the machine. Incorrect voltage may result in damage to the electrical circuit.

Connecting the Water Inlet

- Take the hose delivered with the pump and remove the quick coupling from one end.
- Slide the hose clamp onto the hose and connect to the rear of the Tegramin. Tighten the hose clamp.
- Connect the quick coupling on the other side of the inlet hose directly to the cooling unit's pump outlet (**A**).

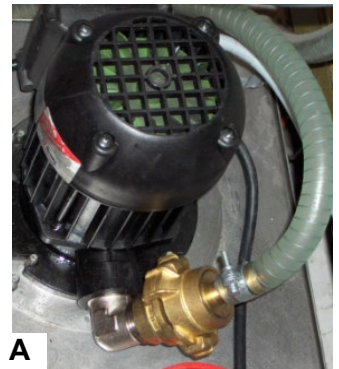

Connecting the Water Outlet

- Mount the water outlet hose onto the water outlet pipe. Use a hose clamp to secure the hose.
- Lead the other end into the mounting hole in the bracket on top of the static filter unit (**B**). Arrange the hose so that it slopes downward towards the drain throughout its length. Shorten the hose, if necessary.

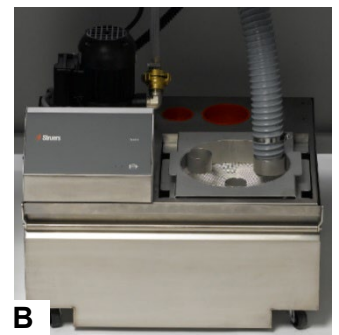

Connecting the Communication Cable

- Connect the communication cable to the Cooli Control Box and then connect to the socket at the rear of the Tegramin.

Installing the Shift Valve (Accessory)

- With the outlet hose mounted onto Tegramin's water outlet pipe, mount the other end of the hose onto the pipe labelled *From Tegramin* on the shift valve.
- Mount a 1.5 m piece of hose onto the pipe marked *Cooli* and lead the other end to the recirculation cooling unit. Use a hose clamp for fastening.
- Mount the second 1.5 m piece of hose onto the pipe marked *Drain* and lead the other end to the drain. Use a hose clamp for fastening.
- Connect the blue compressed air hose to the air outlet on Tegramin and fit the other end to the shift valve, marked *Connect to Tegramin*.
- Connect the plug to the socket at the back of the Tegramin marked *Shift valve*.



NOTE:

Make sure that the hoses slope downward throughout their length, from Tegramin to the shift valve and from shift valve to Cooli (or drain).

Avoid sharp bends in the hoses. Shorten the hoses, if necessary.



HINT:

The Shift Valve for Tegramin set includes some extra pieces not used for Tegramin-25/-30 (1 short piece of hose, 1 reduction piece and 2 hose clamps)

Compressed Air Connections

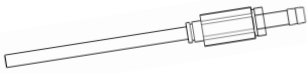

Connection piece



To connect compressed air:

- Mount the connection piece on the compressed air hose and secure it with the hose clamp supplied.
- Connect the air inlet hose to the quick coupling and fit the other end into the compressed air inlet on Tegramin.

NOTE:

The air pressure must be between 6-10 bar (87-145 psi).
Flow: 3.5-4.0 l/min.

NOTE:

Tegramin requires a continuous flow of compressed air through the regulator valve – a faint hissing sound does not mean that there is an air leak.

Emptying the Water / Oil Filter

Tegramin is fitted with a water / oil filter that removes excessive amounts of these substances from the compressed air supply. As a result of this, it is necessary to empty the filter periodically:

- Locate the release outlet valve at the rear of the machine.
- Hold a cloth under the filter to retain any water released and press the release valve.

Release Outlet Valve

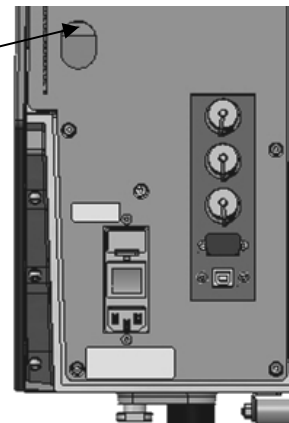

Connection to an External Exhaust System



WARNING

An exhaust system should be connected when using alcohol-based suspensions or lubricants.

Tegramin with Cover / safety Cover

- Connect a 50 mm dia. pipe to the outlet at the rear of the machine, on the cover/safety cover bracket and connect to the exhaust system.



NOTE:

Recommended capacity for exhaust system: 50 m³/h / 1,750 ft³/h at 0 mm water gauge.

Supplying Power



ELECTRICAL HAZARD

- Switch the power off when installing electrical equipment.
- The machine must be earthed (grounded).
- Check that the mains voltage corresponds to the voltage stated on the type plate on the side of the machine. Incorrect voltage may result in damage to the electrical circuit.

The Tegramin is shipped with 2 types of Mains cables:

Single-phase Supply



The 2-pin (European Schuko) plug is for use on single-phase connections.

If the plug supplied on this cable is not approved in your country, then the plug must be replaced with an approved plug. The leads must be connected as follows:

Yellow/green:	earth
Brown:	line (live)
Blue:	neutral

2-phase Supply

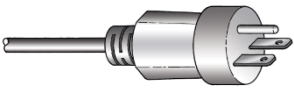

The 3-pin (North American NEMA) plug is for use on 2-phase power connections.

If the plug supplied on this cable is not approved in your country, then the plug must be replaced with an approved plug. The leads must be connected as follows:

Green:	earth (ground)
Black:	line (live)
White:	line (live)

Connection to the Machine

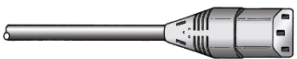

- Connect the power cable to the Tegramin. (IEC 320 connector).
- Connect to the mains power supply.



WARNING

Always turn the power off, remove the plug or the cable and wait 5 minutes before opening the machine or installing additional components.

Mounting the Dosing Modules

- Remove the cover plates.
- Slide the dosing module(s) into the correct position at the rear of Tegramin.
- Secure the module(s) with the attached screws.
- Connect the short piece of tube with the 90° angle and the clear tube to the connectors at the rear of the Tegramin.
- Lead the long tubes from the pumps to the bottles of lubricant/suspension and connect them to the nipple on top of the bottles.
The tubes can be pressed into place in the dosing tube holders on the rear of Tegramin.

When working with alcohol-based products, the tubes must be replaced by the Silicone tubing supplied with the DP Dosing Module. See the section on [Changing Tubes](#) for details.



OP dosing

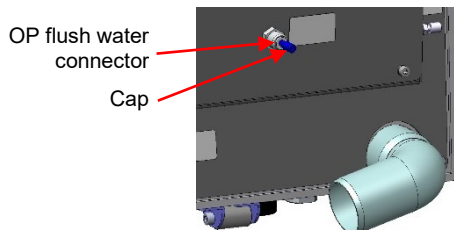

When mounting the module with an OP pump:

- Push the connector disc inwards and remove the blue cap from the OP flush water connector.
- Lead the tube from the OP pump (Pump No. 7 in the picture), press the connector disc inwards and insert the tube into the connector.



HINT:

The tubes from the 2 DP-dosing modules are numbered 1/3 or 2/4. Depending on the position the dosing modules are placed in please remove the numbers that do not match, on both ends of the tube.

Mount the Preparation Disc



NOTE:

Ensure that the cone of the preparation disc and the counterpart on the Tegramin are clean.
Make sure that bowl liner is clean and positioned correctly.
Place the preparation disc carefully on the Tegramin.

- Place the cone disc carefully on the driving pin and rotate it slowly until it is safely engaged.

Noise

Different materials have different noise characteristics. Find the sound pressure level value under [Technical Data](#).

Handling noise (during operation)

Decreasing the force with which the specimen is pressed against the preparation surface, may lower the noise.

Processing time may increase.



CAUTION

Prolonged exposure to loud noises may cause permanent damage to the hearing,
Use hearing protection if exposure to noise exceeds levels set by local regulations.

Vibration

Find the total vibration exposure to hand and arm under [Technical Data](#).

Handling vibration (during operation)

Manual preparation may cause vibrations in hand and arm. Take action to lower the vibration by decreasing the pressure or use a vibration-reducing glove.



CAUTION



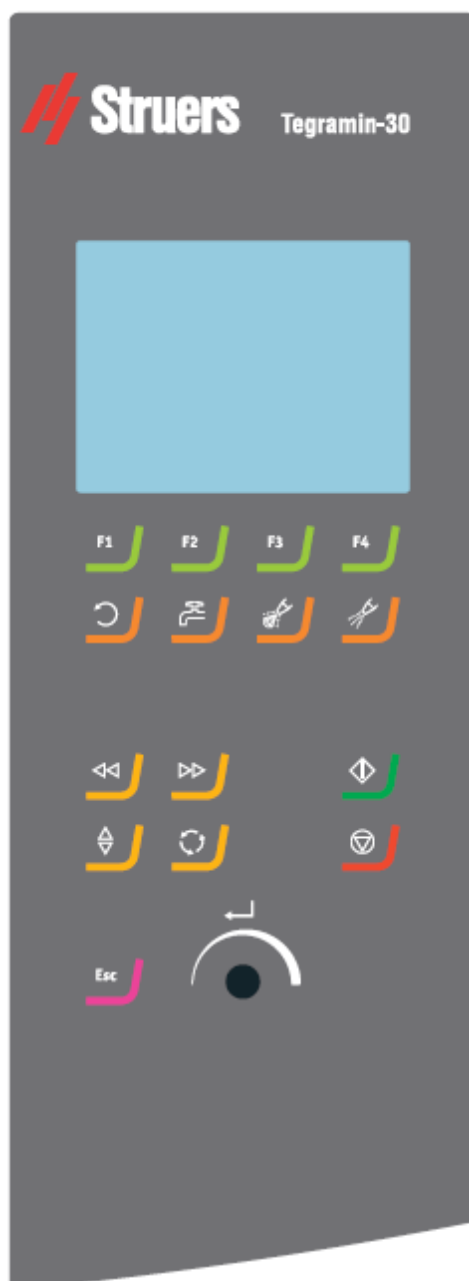

Risk of hand to arm vibration during manual preparation. Prolonged exposure to vibration may cause discomfort, joint damage or even neurological damage.

2. Basic Operation

Front Panel

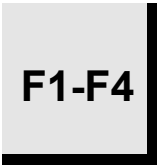
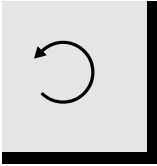

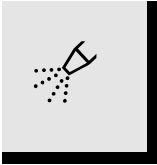
Front Panel Controls

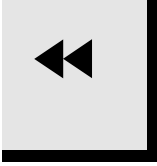
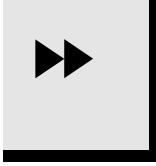
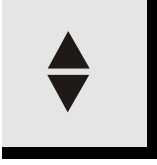
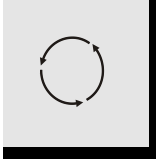
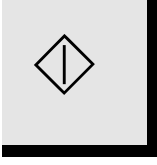
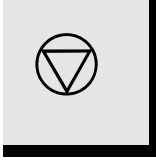
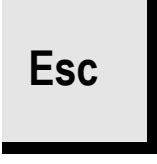
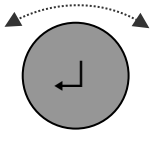
	Key	Function		Key	Function
FUNCTION KEY		Controls for various purposes. See the bottom line of the individual screens.			
DISC ROTATION		Starts rotation of the disc.	WATER		Manual override - push button to apply water (applies water when no process is running). Push button again to stop applying water (water will automatically switch off after 5 min.) ²
LUBRICANT		Only active when dosing module is installed. Manual override – push button to apply lubricant from the doser bottle.	ABRASIVE		Only active when dosing module is installed. Manual override – push button to apply diamond suspension from the doser bottle.
LEFT		Moves the specimen holder head left.	RIGHT		Moves the specimen holder head right.
LOWER/RAISE		Lowers & raises the specimen mover head when preparing single specimens or when adjusting positions of specimen mover plate or specimen holder.	ROTATE		Rotates the Specimen Mover Plate.
START		Starts the preparation process.	STOP		Stops the preparation process.
ESC		Returns to the Main Menu or aborts functions/changes.	Turn/Push Knob		Used for entering and changing steps and parameters. Combined cursor and enter key. Enables selected parameter values to be activated for editing. Saves the edited parameter values. Toggles when only 2 options available.

² If connected to recirculation unit, recirculation water will be applied.

Reading the Display

The display on the front panel provides different levels of status information. For example, when the machine is switched on using the Mains switch located at the rear, on the right-hand side of the machine, the display informs you about the physical configuration of the Tegramin and the version of software that is installed:

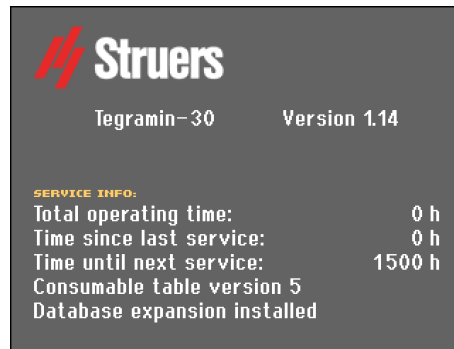

When operating the Tegramin, this display is the user-interface to Tegramin's software.

The display is primarily divided into 2 areas. The position of these areas and the information they contain are explained in the illustration below, which uses the *Options* menu as an example:



- A** Heading: this is a navigational aid, telling you where you are in the software's hierarchy.
- B** Information fields: these will be either numerical values or text fields, providing information associated with the process shown in the heading. The inverted text shows the cursor position.

Manoeuvring in the Menu Structure

To select items in the menu:



Turn knob to select a menu, method group or a parameter.



Push knob to open or activate the selection.

Esc Press **Esc** to return to the Main menu.

Acoustic Signals

When pressing a key, a short beep indicates that the command has been accepted, whereas a long beep indicates that the key cannot be activated at the moment.

The 'short' sound can be switched on or off in *Configuration* under *Options*.

Software Settings

When switching Tegramin on for the first time, the *Select language* screen will appear (to change the language after this, refer to “*Changing the Language*”).



Turn knob to select the language you prefer.



Push knob to accept the language.

You will now be prompted to set the date.



Turn knob to select and to adjust the settings.



Push knob to accept the settings.

You will now be prompted to set the time.

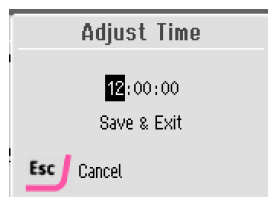

Turn knob to select and to adjust the settings.



Push knob to accept the settings.



When Time and Date have been set, turn knob to select *Save and Exit*.



Push knob to *Save and Exit* (Save the settings and return to the *Main menu*).

The *Main menu* now appears in the language you have chosen.

During normal operation, immediately after start up, where the splash screen is displayed, the software goes to the screen that was used before the machine was switched off. Thus, you can continue exactly where you left last time the machine was used.

To go to the *Main menu*, use the **Esc** key. The *Main Menu* is the highest level in the menu structure. From this menu, you can enter all the other menus.

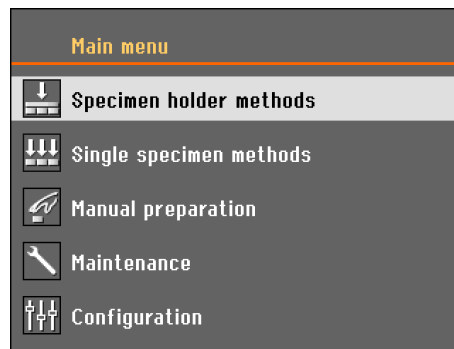

Changing the Language



Turn the knob to select *Configuration*.



Push knob to activate the *Configuration* menu.



Turn the knob to select *Options*

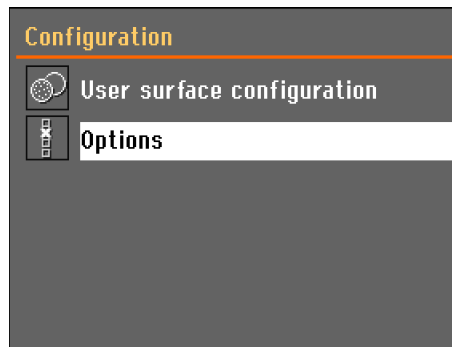

Push knob to activate the *Options* Menu.



Turn knob to select *Language*.

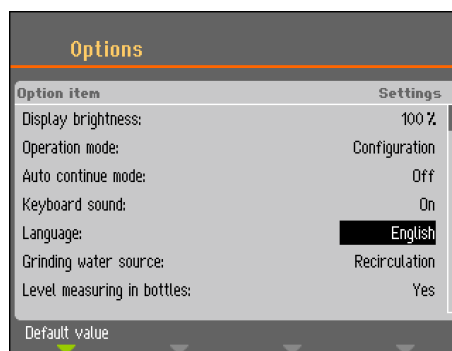

Push knob to activate the *Select language* pop-up menu.



Turn knob to select the language you prefer.





Push knob to accept the language.

The *Configuration* menu now appears in the language you have chosen.

Check if there are any other settings that need changing in the *Options* menu. If not, Push **ESC** to return to the *Configuration* menu.

Otherwise use the Turn/Push knob to select and change the required parameters.

Editing Numeric Values



Turn knob to select the value to be changed, e.g. *Display brightness*:

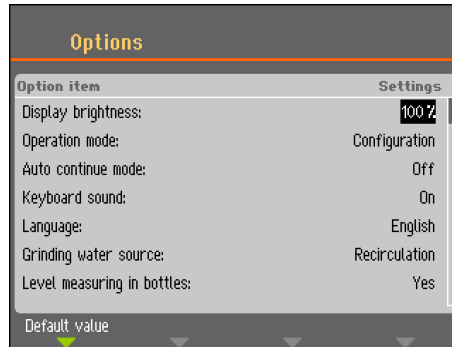

Push knob to edit the value.



A scroll box appears around the value.

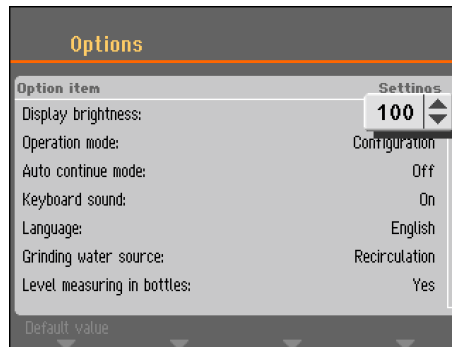

Note:

If there are only two options, the popup box is not displayed. Pressing the knob (Enter) will toggle between the 2 options.



Turn knob to increase or decrease the numeric value (or to toggle between the two options).



Push knob to accept the new value. (Pressing **Esc**, aborts the changes, preserving the original value.)

Editing Alphanumeric Values



Turn knob to select the text value to be changed, e.g. *Keyboard sound*:

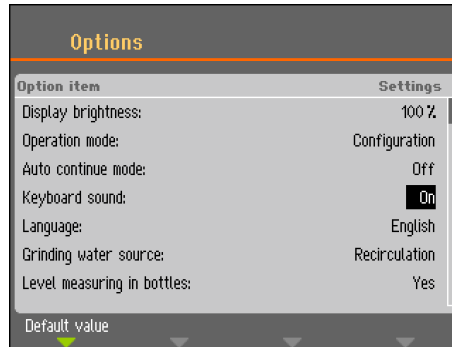

Push knob to toggle between the 2 options.

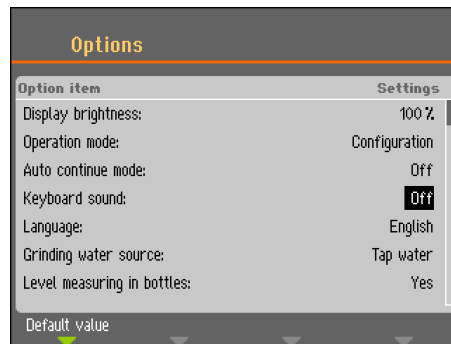

Note:

If there are more than two options, a popup box is displayed. Turn knob to select the correct option.



Press **Esc** to accept the option and return to the previous menu
Or turn knob to select and edit other options in the menu.

Operation Mode

In *Operation mode* 3 different user levels can be set.

Production:	Methods can be selected and viewed but no editing is possible.
Development:	Methods can be selected, viewed and edited
Configuration:	Methods can be selected, viewed and edited and bottles can be configured.

Changing Operation Mode

To change the operation mode, go to the *Configuration* menu and then the *Options* menu. Select **Operation mode** to get access to the *Operation mode* menu.



Push knob to select Pass code.

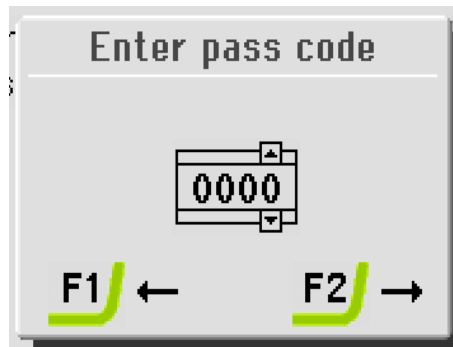

Use the F1 and F2 keys and the knob to enter the current pass code (The default pass code is '2750').:

- Use the F1 and F2 keys to select digits (F1 moves to the left, F2 moves to the right).
- Turn knob to change the digits and press knob to enter the pass code.

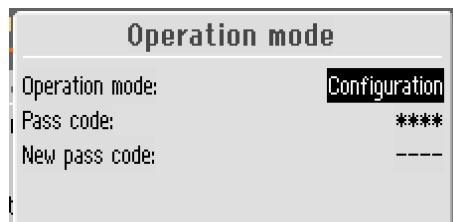

Push knob to select **Configuration**.

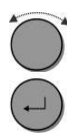
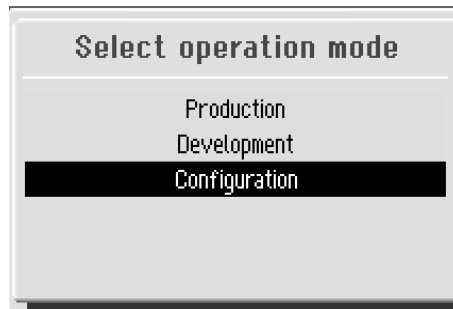

Select the desired operation mode and push knob to confirm.

New Pass Code

A New pass code can also be selected from the *Operation mode* menu.



HINT:

When a pass code is set the operator has 5 attempts to enter the correct pass code after which the Tegramin will be locked. Re-start Tegramin using the Main Switch then enter the correct Pass Code.



NOTE:

Remember to make a note of the new Pass code as settings can no longer be changed without the Pass code.

Bottle Configuration

Before a preparation can be started, the bottles with suspensions and lubricants must be configured.



Turn the knob to select *Configuration*.



Push knob to activate the *Configuration Menu*.



Turn the knob to select *Bottle configuration*

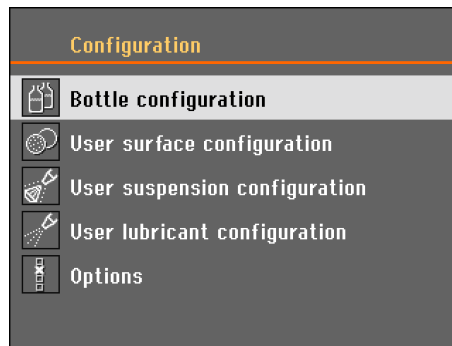

Depending on the number of pumps installed, from 1 to 7 configuration possibilities are displayed.



Turn knob to select the first bottle.



Push knob to toggle between *Suspension*, *Lubricant* or *None* (if no dosing bottle is connected).

If a bottle with diamond suspension is connected to pump 1, select *Suspension*.



No.	Susp./Lub.	Type	Remaining
1	Suspension	DP-Suspension, P 15 µm	200-250ml
2	None		Disabled
3	None		Disabled
4	None		Disabled
5	None		Disabled
6	None		Disabled
7	None		Disabled



Turn knob to select *Type*.



Push knob to display the *Select suspension type* menu.

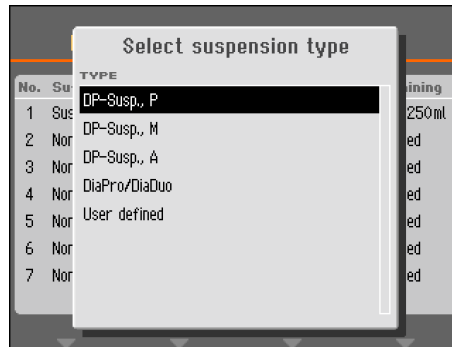

Select the correct type and grain size of the suspension you are using.



Push knob to save the selection.



Turn knob to select *Remaining*.



Push knob and a pop-up will appear.

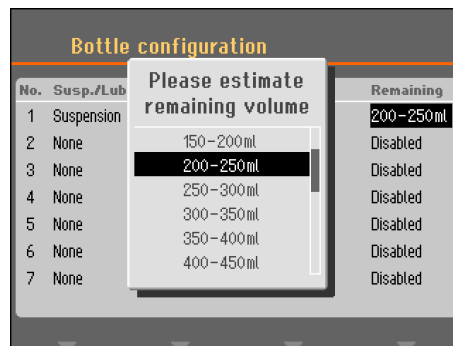

Turn knob to select the approximate volume that is in the bottle and push the knob to save this value.



(This function requires that the parameter: *Level measuring in bottles* in the *Options* menu under *Configuration* is set to Yes.)

The amount of every suspension or lubricant used in the following preparations is automatically calculated and deducted from the remaining volume in each of the bottles and a message is displayed when the calculated volume gets too low.

Repeat the procedure for all of the following pumps / bottles until all bottles are configured correctly.



*Tegramin-25/ -30
Instruction Manual*

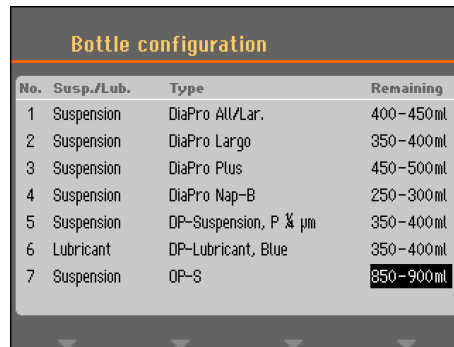

No.	Susp./Lub.	Type	Remaining
1	Suspension	DiaPro All/Lar.	400-450ml
2	Suspension	DiaPro Largo	350-400ml
3	Suspension	DiaPro Plus	450-500ml
4	Suspension	DiaPro Nap-B	250-300ml
5	Suspension	DP-Suspension, P μ m	350-400ml
6	Lubricant	DP-Lubricant, Blue	350-400ml
7	Suspension	DP-S	350-900ml



Esc

Press **Esc** until the Main menu appears.
Tegramin is now ready to set up a preparation process.

Preparation Process Setup



HINT:

For information on selection of the correct preparation parameters and consumables, visit the section on [How to select a preparation method](#) on the Struers Knowledge website.

Selecting a Preparation Mode

Three different preparation modes can be selected.

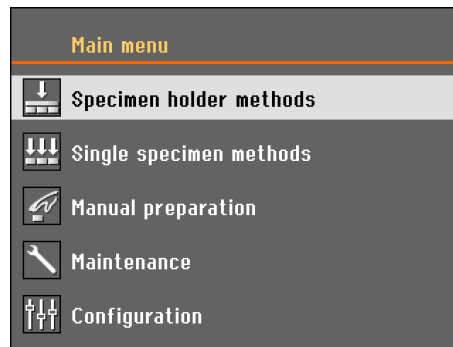

- Specimens can be clamped in specimen holders and prepared
- Specimens are prepared as single specimens
- Specimens can be prepared manually (not for Tegramin with Safety cover)

Select the appropriate preparation mode by turning the knob and activate the selection by pushing the knob.

- Specimens holder methods
or
- Single Specimen methods

The first screen displays the Method groups. On a new machine only the *Struers Metalog Guide* Methods and *New Group* are shown.

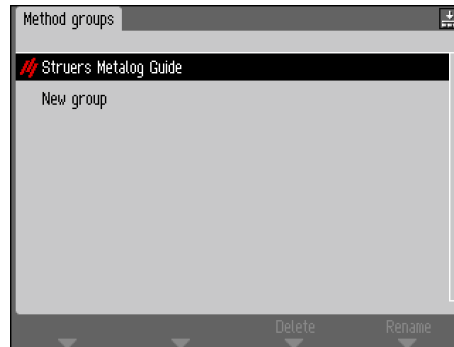

Methods can be organized into user defined groups, making it easier to find the preparation method required. Up to 10 groups can be made.

Each group can contain up to 20 different preparation methods. Each method can have up to 10 steps.

The contents of the Method Groups are identical, no matter if *Specimen holder methods* or *Single specimen methods* is selected. A method group or method created in one selection is automatically created in the other selection as well.

All method parameters are exactly the same when a method is created initially, except for the force. The relation between single specimen force and specimen holder force is 1 to 6, i.e. 30 N in single specimen mode will be 180 N in specimen holder mode and vice versa.

However, when a method parameter such as time or force is changed later on, the other method will **not** be updated with the new values. This will allow for individual modifications due to specimen size and/or number.

If a preparation surface or suspension is changed in a method, this **will** be reflected in the other method.

Selecting a Preparation Method

Use the Turn/push knob to navigate in the menu.



HINT:

A small icon in the top right corner shows if *Specimen holder methods* or *Single specimen methods* are selected.



Indicates *Specimen holder methods*



Indicates *Single specimen methods*



Turn knob to select a Method group.



Push knob to open the method view.

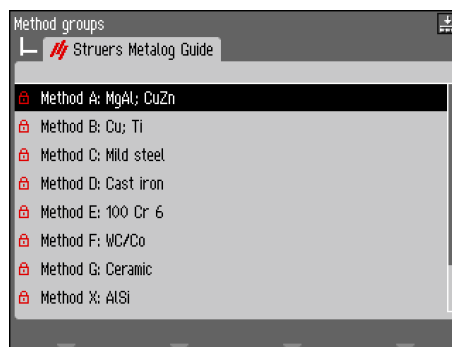

Turn knob to select a Method.



Push knob to open the step view.

Tegramin-25/ -30 Instruction Manual



	Surface	Suspension	Lub.	Time/µm
1	SIC-Pap. #820		Water	1:00 min
2	Largo	DiaP. All/Lar.		3:00 min
3	Mol	DiaP. Mol		5:00 min
4	Chem	OP-U		1:00 min
5	New step			

Copy step Insert step Delete step Save functions

Creating a Preparation Method

All parameters can be changed to optimise the preparation method. Each method can contain up to 10 steps.

Use the knob to select a *New method*.



Push knob to open the step and display the parameter view.

Tegramin-25/-30 Instruction Manual

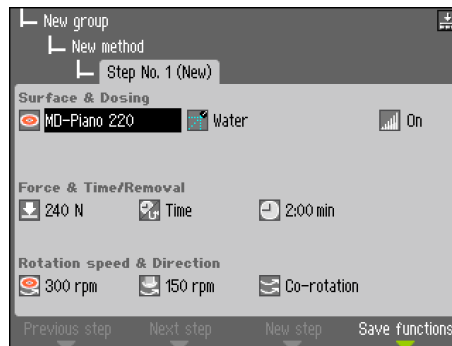

Default settings for a typical preparation process are already selected. e.g.:

Step No. 1 is designed to be a plane grinding step.

Step No. 2 is designed to be a fine grinding step.

Step No. 3 is designed to be a polishing step.

Change the settings to optimise the preparation method.

↓ Use the knob to select the parameter to be edited e.g. *Force & Time/ Removal*.

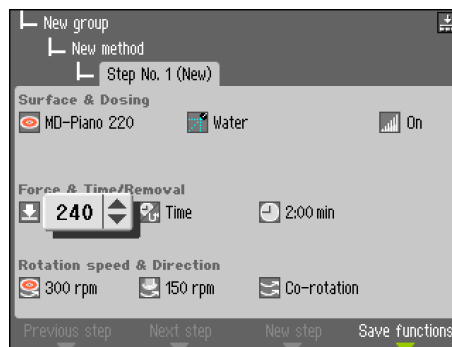

Use the knob to edit the parameter/ value and push the knob to confirm the new value. (Pressing **Esc**, aborts the changes, preserving the original value.)

Tegramin-25/ -30
Instruction Manual



An asterisk * next to the method name indicates that a change has been made

After the step has been modified,

Press **F3** *New step* and step 2 is displayed – *Step No. 2*.

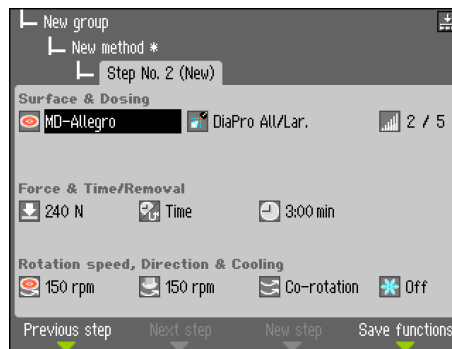

NOTE

F3 *New step* is only available after at least one modification of the current preparation step.

When all necessary preparation steps have been created and modified, the method should be saved.

Press **F4** *Save* and a pop-up is displayed.

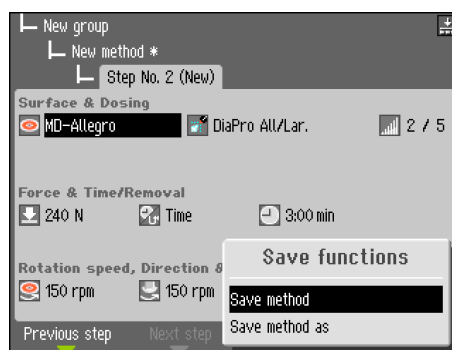

Select *Save method* to save the method, with the current name and current method group.

OR select *Save method as* and specify a New Method group and a New method name.

An entire preparation method can be created step by step. However, an easier way would be to modify an existing preparation method. All existing preparation methods, including Metalog Guide methods can be used for modification.

Modifying an existing preparation method

Select the preparation method to be modified, go through the different preparation steps and make the necessary adjustments. Then press **F4** *Save* and select *Save method as* to save the method under a different name and, if wanted, in a different group.

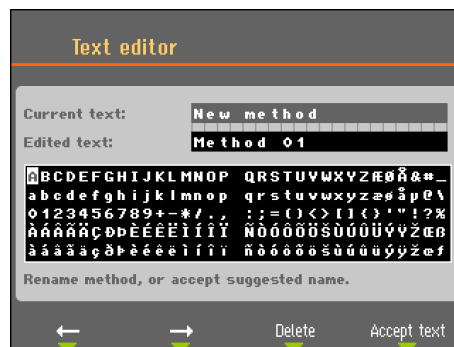

Locking a Preparation Method

To avoid accidental changes or deletion of a preparation method, a method can be locked.

In the *Method view* screen, select the method to be locked, e.g. Method 01.

Press **F1** *Change status*

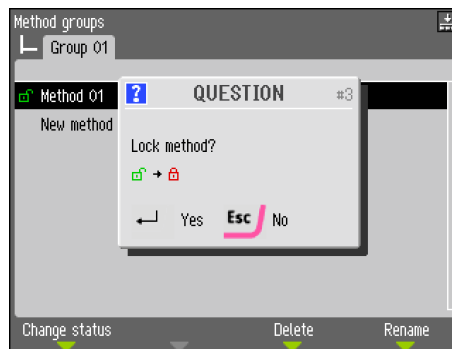

Push knob to lock the method.

The green open lock will change to a red closed lock.

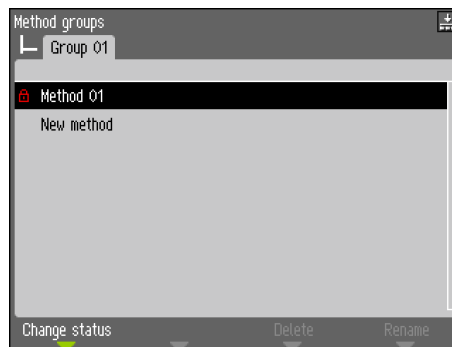

The lock symbol in front of the method name has now changed status and shows the locked method. This method can still be modified, but when saving any changes, it is only possible to select *Save method as*.

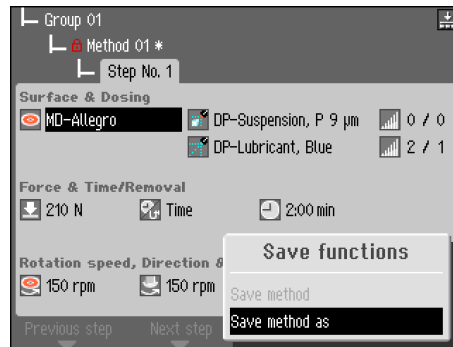

Unlocking a Preparation Method

To unlock a method, repeat the procedure above.

Setting Dosing Levels

When suspensions and/or lubricants are used in a preparation step, first the type of suspension or lubricant is selected and afterwards the dosing level.

Following "Level:", two values can be set, e.g. 1 / 5

The first value [1] is the pre-dosing level, the amount of suspension or lubricant applied onto the surface before the actual step is started. This is used to provide a lubricated surface to avoid any damage that could occur if the specimens would be running on a dry surface. Depending on the frequency of use and the type of surface different values should be set. For frequently used surfaces a lower value can be used than for surfaces used only once in a while.

The second value [5] is the dosing level maintained throughout the preparation. This is set according to the type of surface: soft, napped polishing cloths require more lubricant than hard, flat polishing cloths or fine grinding discs. Fine grinding discs require a lower dosing level of abrasive than polishing cloths.

Option	Settings for		Change increment
	Pre-dosing	Dosing	
Dosing Level	0 - 10	0 - 20	1

e.g.

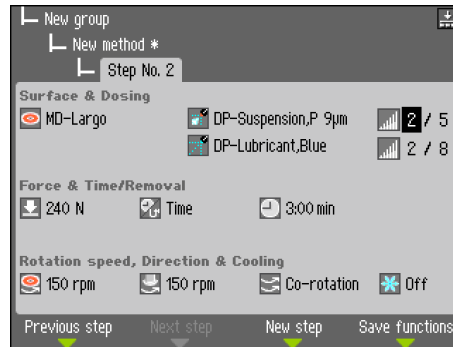

Starting the Preparation Process



NOTE:

The operator must be familiar with the precautions listed in the Safety Precaution Sheet before operating Tegramin.

Tegramin without Cover

Once the desired method has been selected,

- Press Start  to start the preparation.



WARNING

- Do not attempt to collect a specimen from the tray while the disc is running.
- While the disc is rotating, ensure your hands are kept well clear of its periphery and out of the bowl.

Tegramin with Cover / Safety Cover

Once the desired method has been selected,

- Close the cover.
- Press Start  to start the preparation.

Stopping the Process

The process stops automatically when the set preparation time has expired

- To stop the process before the set preparation time has expired, press .

Spin Function

The built-in Spin function can be used to remove water from a MD-grinding disc or a SiC-paper before removing it, or to dry a preparation disc or an MD-Chem polishing cloth.

- Press and hold the Disc key  to start the Spin function.
- Release the Disc key to stop the Spin function.

Inserting Specimen Holders or Specimen Mover Plates

Inserting a Specimen Holder

The Tegramin can be operated with either specimen holders or specimen mover plates for single specimens.

- Press the Raise/Lower  button to ensure that the head is fully raised.
- Push and hold the black button on the head.
- Insert the specimen holder and rotate it until the three pins are aligned and then push the holder upwards until it clicks in position.
- Let go of the black button.
- Remove your hand from the holder.

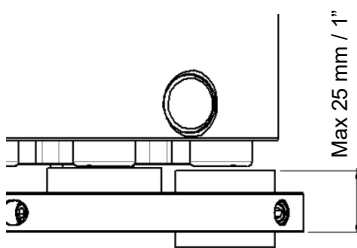

NOTE:

When working with specimen holders make sure that the clamping screws fixating the specimens do not protrude from the specimen holder.
Use different length of screws for specimens with different diameters.

NOTE:

The height, measured from the bottom of the specimen holder to the top of the specimen, must not exceed 25 mm.

Inserting a Specimen Mover Plate

- Use the Raise/Lower  button to ensure that head is fully raised.
- Push and hold the black button on the head.
- Insert the specimen mover plate and rotate it until the three pins are aligned and then push the specimen mover plate upwards until it clicks in position.
- Let go of the black button.
- Remove your hand from the mover plate.

Lowering the Specimen Mover Head

(only when using Specimen Mover plates)

- Press the Raise/Lower  button to lower the specimen mover head into position ready for preparation.
The distance between the preparation disc and the specimen mover plate should be about 2 mm.
To adjust the distance please see the chapter: [Adjusting the Specimen Mover Plate Height](#).



WARNING

Keep hands clear of specimen mover plate when lowering it.

Adjusting the Horizontal Position of the Specimen Holder / Mover Plate

To adjust the horizontal position of the specimen holder/ mover plate over the preparation disc:

- Press the Left ◀ and Right ▶ buttons to adjust the horizontal position.

The specimen holder/ mover plate should be positioned to allow the specimens to run 3 – 4 mm over the edge of the preparation disc.



NOTE:

The height of the specimen should be between 8 – 35 mm and not exceed 0.7 x specimen diameter.

Example: A specimen with a diameter of 30 mm should not be higher than $30 \times 0.7 = 21$ mm.

Placing the Specimens in a Mover Plate

- Place the specimens in the holes to the front.
- Rotate the mover plate 120 ° by pressing the Rotate  key on the control panel.
- Repeat until all specimens are placed / holes are used.

Recommendations for Grinding Single Specimens

Do not use plane grinding with coarse abrasives when preparing single specimens. It is normally not necessary, and the use of coarse abrasives can result in un-plane specimens.

If, for whatever reason, it is necessary to grind using coarse abrasive, the planeness may be improved using the following recommendations:

- Use the smallest grain size possible (bear in mind that this will increase the overall preparation time).
- Use a mounting resin with a wear resistance similar to the specimens wear resistance.
- Use 150 rpm for both grinding disc and specimen mover. (When using lower speeds decrease the speed on both the disc and the specimen mover).
- Use co-rotation. (both the disc and the Specimen Mover Head rotate counter-clockwise).
- Use low force.
- Position specimen mover head of Tegramin so that the specimens do *not* pass over the centre of the preparation disc.
- Lower the specimen mover plate as much as possible, without contacting the preparation surface

Manual Preparation

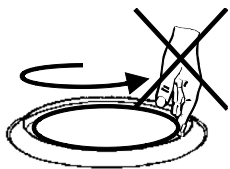

WARNING

- While grinding manually, be careful not to touch the grinding surface.
- Wear gloves to protect fingers from abrasives and warm specimens.
- Wear safety goggles if required in the consumables SDS.
- Do not attempt to collect a specimen from the tray while the disc is running.
- While the disc is rotating, ensure hands are kept well clear of its periphery and out of the bowl.



HINT:

Manual preparation cannot be used on Tegramin with Safety cover.

- From the *Main menu*, select *Manual preparation*.

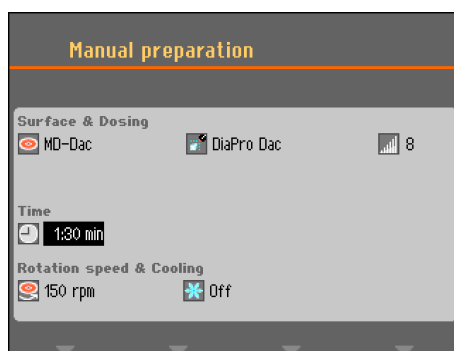

- Set the individual preparation parameters and consumables used.
- Press Start .
The disc will start turning at the pre-set speed and dosing will commence.

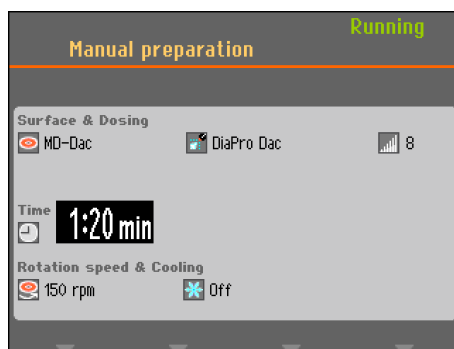

The disc and dosing will stop automatically when the pre-set time expires.

- To stop both the disc and the dosing before the time has expired, press Stop .

3. Maintenance

Daily Service

- Clean all accessible surfaces with a soft, damp cloth.
- Clean the bowl (see [Cleaning the Bowl](#)).



NOTE:

Do not use a dry cloth as the surfaces are not scratch resistant. Grease and oil can be removed with ethanol or isopropanol.

NOTE:

Never use acetone, benzol or similar solvents.

Weekly Service

- Clean painted surfaces and the control panel with a soft damp cloth and common household detergents. For heavy duty cleaning, use Struers Cleaner (Cat. No. 49900027).
- Remove the preparation disc and the bowl liner.
- Remove all dirt from the drain tube.
- Clean (or discard) the bowl liner and insert the clean (or new).
- Put the preparation disc back in place.
- Clean the pressure feet and pistons applying the force on the specimens and specimen holder. (Select the *Maintenance menu* and *Cleaning of specimen mover head*).
- Press the release outlet valve to drain the water/oil filter (please see section on [Emptying the Water / Oil Filter](#)).



NOTE:

Make sure, that the cleaning water is not drained into the recirculation unit (if any).

Tegramin with Cover / Safety Cover

- Clean the cover with a soft damp cloth and a common household anti-static window cleaning agent.

Cleaning of Tubes

Clean the tubes weekly or every time bottles are changed or replaced, thus avoiding lubricant/suspension left in tubes interfering with the preparation procedures.

To clean the tubes:

- Go to the *Maintenance* menu and select *Cleaning of tubes* then follow the on screen instructions.



No.	Susp./Lub. name	Status	Select
1	DiaPro All/Lar.	Clean	No
2	DiaPro Largo	Clean	No
3	DiaPro Dac	Used	Yes
4	DiaPro Dur	Clean	No
5	DP-Suspension, P 3 µm	Used	Yes
6	DP-Lubricant, Blue	Used	No
7	DP-S	Clean	No

Start cleaning Select "Used"

- Press F4 to select all the tubes that have been used. To select or unselect a single tube move the cursor to the respective tube and press Enter.
- When 1 or more tubes have been selected, press F1 to start the cleaning process.
- Follow the instructions on the screen to complete the operation.

Cleaning the Bowl

Tegramin is equipped with an automatic bowl cleaning function. To clean the bowl:

- Go to the *Maintenance* menu and select *Cleaning of bowl*.
- Set the cleaning time, the speed of the disc and select additional water if requested.

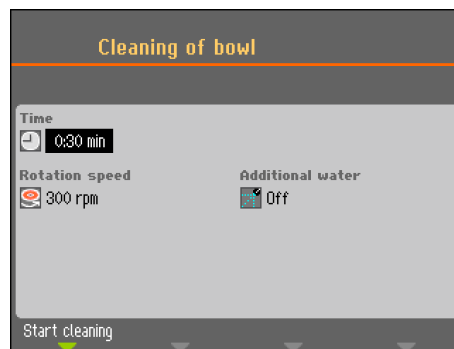

- Press F1 to start the cleaning process.



NOTE:

If a bowl liner is used, remove it prior to using the *Cleaning of bowl* function, to avoid flushing the debris into the drain.

Cleaning of Specimen Mover Head

Tegramin is equipped with a function that allows you to clean the feet applying the force onto the specimens and the lock that secures the specimen mover plate for single specimens.

- To activate these functions:
Go to the *Maintenance* menu and select *Cleaning of specimen mover head*.

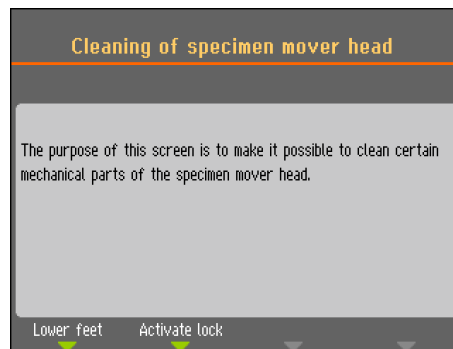

- Press **F1** or **F2** to activate either of the functions.
 - Press **F1** to lower the feet - the pistons can now be cleaned or lubricated.
 - Press **F2** to activate the lock.
This is mainly to check its function and to remove dirt or particles that may obstruct its movement and the locking function.



NOTE:

Never try to force any of the movements.
If the components do not move as they should contact Struers Service.

Calibration of Pump Capacity

The amount of liquid delivered onto the preparation surface can change over time. To be able to keep a constant dosing level, every pump can be calibrated individually.

For highest precision we recommend calibrating the pump capacity every 3 months as well as each time the tubes are changed.

To calibrate the pumps:

- Go to the *Maintenance* menu, select *Calibration and adjustments* and then select: *Calibration of pump capacity*.

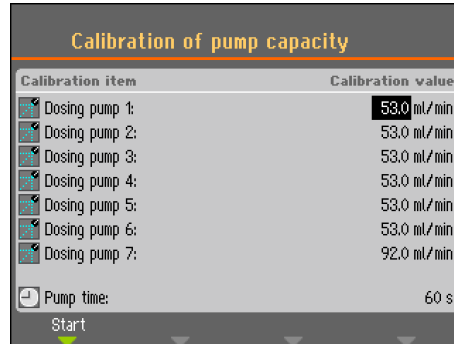

- Select the pump to be calibrated by moving the cursor to the respective position.
- Exchange the bottle with suspension or lubricant with a container with water and press F1 to start the pump.
- When the water coming out of the nozzle is clean (clear) stop the pump by pressing F1 again.
- Take an empty measuring cylinder and place it underneath the dosing nozzle. (For highest accuracy weigh the measuring cylinder).
- Press F1 again to start the calibration process. The pump will run for precisely 60 seconds.
- After the pump stops, measure the volume of water in the container (or weigh the measuring cylinder again).
- Enter the amount of water measured and confirm the new value by selecting *Save & Exit*.

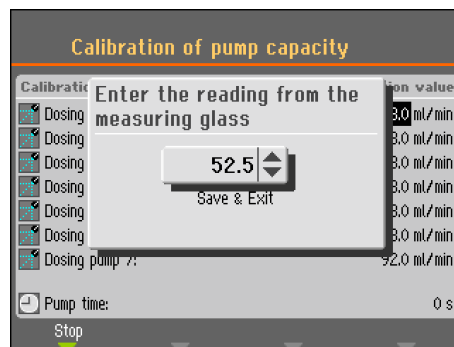

Based on the new calibration value, Tegramin will now recalculate the dosing levels to ensure the best possible accuracy.

- Repeat the process for the other bottles.

Adjustment of Tube Cleaning Time

Tegramin is also equipped with a function to specify the length of time needed to clean the whole length of the tube. These values are also used when refilling the tube with suspension or lubricant after a tube cleaning. Therefore, the cleaning times can be adjusted e.g. if the tubes have been shortened after installing the dosing units.

To adjust the tube cleaning time:

- Go to the *Maintenance* menu, select *Calibration and adjustments* and then select: *Adjustment of tube cleaning time*.

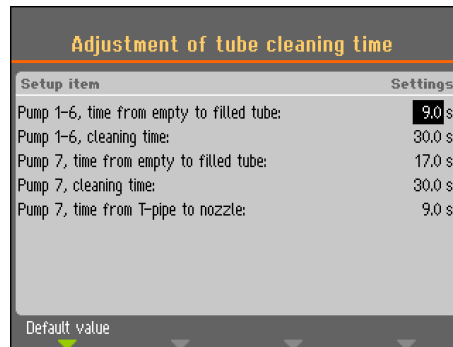

Time from empty to filled tube
 Pumps 1-6

- Increase the time if: Diamond suspensions or lubricants do not reach the dosing nozzles after a cleaning process before a preparation step starts.
- Decrease the time if: Diamond suspension or lubricant is dosed before the pre-dosing is started

Pump 7

- Increase the time if: OP suspension does not reach the dosing nozzles after a cleaning process before a preparation step starts.
- Decrease the time if: too much OP suspension is dosed before the pre-dosing is started

Cleaning time

Cleaning time can be set for all tubes. The cleaning time specifies the length of time the pump will run during a cleaning cycle. This value can be changed depending on personal preferences.

Time from T-pipe, to nozzle
 (Pump 7 only)

The time from the T-pipe, where the water for flushing is added, to the nozzle can also be set.

Changing Tubes

When working with alcohol-based products, the tubes mounted in the pumps supplied with Tegramin will harden over time. Therefore, a piece of silicone tubing is supplied with the Tegramin dosing modules as Silicone has a better resistance against alcohol.

To exchange the tube with a Silicone tube:

- Separate the doser tubes at the white coupling (the coupling should stay on the tube connected to Tegramin).
- Disconnect the other end of the tube from the Tegramin ①.

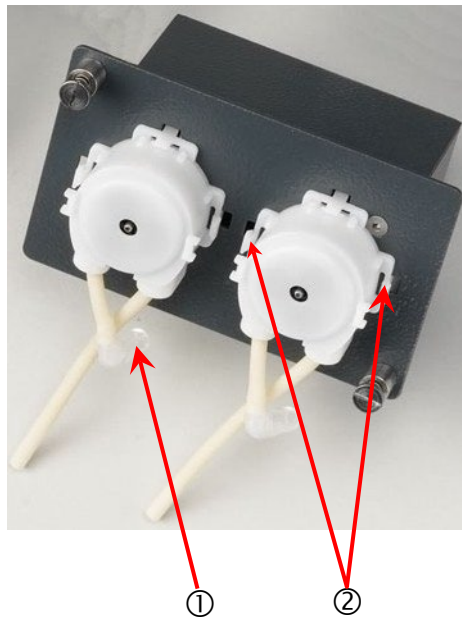

- Press the two tabs at the base of the pump ② and remove the pump from the shaft.
- Press the two tabs on the pump ③ and remove the bottom cover.

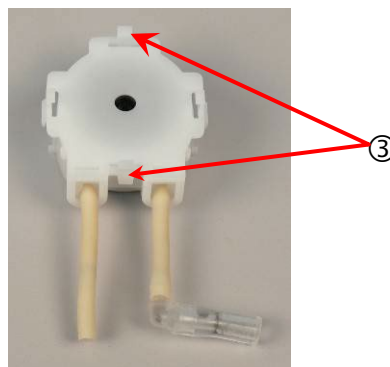

- Remove the 3 rollers.



- Remove the tube and transfer the white clips and the connector to the new silicone tube. Note that the two clips must be the same distance apart as on the original tube.

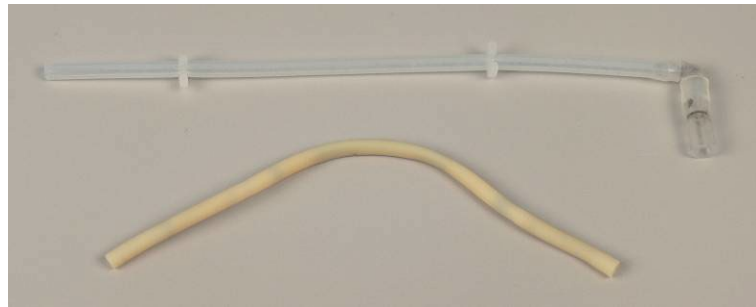

- Fit the new tube into the housing and press firmly into place. Press the 3 rollers in the pump housing.



- Re-mount the bottom cover.
- Press the pump back onto the shaft, then re-connect the tubes
- Check that the tubes are connected correctly so that liquid is pumped to the dosing nozzles.

Adjusting the Specimen Mover Plate Height

Tegramin is equipped with a mechanism to adjust the distance between the specimen mover plate and preparation disc.

To adjust the distance:

- Go to the *Maintenance* menu, select *Calibration and adjustments* and then select: *Adj. of specimen mover plate height* and follow the on screen instructions.

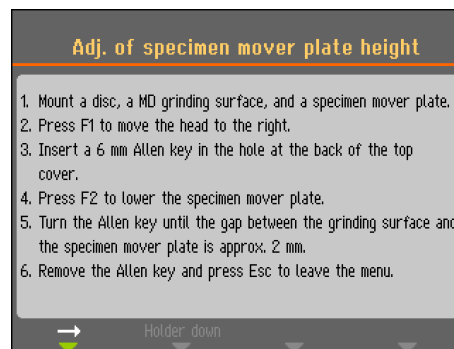
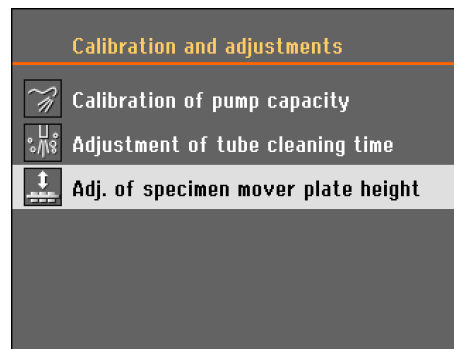

- Turn Allen key Clockwise to increase the gap.
- Turn Allen key Counter - Clockwise to decrease the gap.

Reset Functions

It can become necessary to reset certain functions to the factory settings using the *Reset functions* menu. For example, when exchanging dosing modules which have a different pump configuration (e.g. mounting a dosing module with 1 DP pump in place of a 2 DP dosing module).

To reset methods or configuration:

- Go to the *Maintenance* menu and select: *Reset functions*.

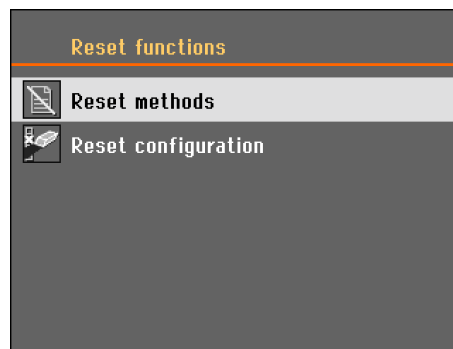

Reset Methods

- When selecting *Reset methods* there are 2 selections possible: Reset methods in one group, and Reset methods in all groups.



NOTE:

When the preparation methods are reset in one group or in all groups they are deleted and cannot be re-established.

Reset Configuration

- Select *Reset configuration* to set all configuration parameters back to their default settings.
- Switch Tegramin off, then on again and reconfigure the settings.





HINT:



It is advisable to make a note of your own customised settings under *Options* or *Bottle configuration* before carrying out a *Reset configuration*.

Yearly

Testing Safety Devices

- Press Start .
- The machine starts operating.
- Activate the Emergency-stop.
- If operation does not stop, press Stop  and contact Struers Service.

Tegramin with Safety cover

- Close the safety cover.
- Press Start .
- The machine starts operating.
- Open the safety cover.
- If operation does not stop, press Stop  and contact Struers Service.

Checking Cover Springs

- The cover's open and close function is supported by two springs.
- Inspect that springs are intact and free of corrosion.
 - Close the cover and verify that the downward movement is dampened.
- If the cover is not dampened, contact Struers Service.



WARNING

Do NOT use the machine with defective Safety Devices.
Contact Struers Service.

Spare Parts

Please see [Spare Parts and Diagrams](#) in the Reference Guide section of the Instruction Manual.

4. Cautionary Statements

List of Safety Messages in the Manual



WARNING

Do not use the Emergency stop for operational stop of the machine during normal operation.
BEFORE releasing (disengaging) the Emergency stop, investigate the reason for activating the Emergency stop and take any necessary corrective action.



ELECTRICAL HAZARD

- Switch the power off when installing electrical equipment.
- The machine must be earthed (grounded).
- Check that the mains voltage corresponds to the voltage stated on the type plate on the side of the machine. Incorrect voltage may result in damage to the electrical circuit.



WARNING

An exhaust system should be connected when using alcohol-based suspensions or lubricants.



ELECTRICAL HAZARD

- Switch the power off when installing electrical equipment.
- The machine must be earthed (grounded).
- Check that the mains voltage corresponds to the voltage stated on the type plate on the side of the machine. Incorrect voltage may result in damage to the electrical circuit.



WARNING

Always turn the power off, remove the plug or the cable and wait 5 minutes before opening the machine or installing additional components.



CAUTION

Prolonged exposure to loud noises may cause permanent damage to the hearing,
Use hearing protection if exposure to noise exceeds levels set by local regulations.



CAUTION

Risk of hand to arm vibration during manual preparation. Prolonged exposure to vibration may cause discomfort, joint damage or even neurological damage.



WARNING

- Do not attempt to collect a specimen from the tray while the disc is running.
- While the disc is rotating, ensure your hands are kept well clear of its periphery and out of the bowl.



WARNING

Keep hands clear of specimen mover plate when lowering it.



WARNING

- While grinding manually, be careful not to touch the grinding surface.
- Wear gloves to protect fingers from abrasives and warm specimens.
- Wear safety goggles if required in the consumables SDS.
- Do not attempt to collect a specimen from the tray while the disc is running.
- While the disc is rotating, ensure hands are kept well clear of its periphery and out of the bowl.



WARNING

Do NOT use the machine with defective Safety Devices. Contact Struers Service.



WARNING

Safety critical components are to be replaced after a maximum lifetime of 20 years. Contact Struers Service for information.

5. Transport and Storage



NOTE:

Store the packing crate, bolts and brackets for use whenever Tegramin is transported/re-located.

Failure to use the original packaging and fittings could cause severe damage to the tester and will void the warranty.

Follow these steps:

- Clean the machine.
- Disconnect suspensions / lubricants and make sure that the tubes are empty.
- Remove the preparation disc.
- Place the mover head transportation bracket and secure it with the screw.
- Disconnect power, water and compressed air.
Remember to place a piece of cloth in bowl to collect remaining water (if any).
- Position the straps on the outer side of the feet.
- Arrange the straps and the lifting bar as described in [Unpacking Tegramin](#).
- Move the machine to its new location.

If the machine is bound for long-time storage or shipping, follow these additional steps:

- Lift and place the machine on the shipment pallet.
- Secure the machine to the pallet using the transportation brackets.
- Build the transport crate onto the pallet.

6. Disposal



Equipment marked with a WEEE symbol  contain electrical and electronic components and must not be disposed of as general waste.

Please contact your local authorities for information on the correct method of disposal in accordance with national legislation.

Reference Guide

Table of Contents	Page
1. Struers Knowledge	69
2. Accessories and Consumables	
Accessories	70
Specimen Holders.....	70
Consumables.....	70
Attaching a Cover (optional/accessory).....	70
3. Trouble-shooting	
Error Messages.....	71
Adjusting the Horizontal Position of the Specimen Holder / Mover Plate.....	79
4. Service Information	
Service Check.....	81
5. Spare Parts and Diagrams	
Safety Related Parts of the Control System (SRP/CS).....	82
Spare Parts List.....	83
Diagrams.....	83
Block Diagram.....	84
Air Diagram	85
Water diagram	86
6. Legal and Regulatory	87
FCC Notice	87
7. Technical Data	88

1. Struers Knowledge

Mechanical preparation is the most common method of preparing materialographic specimens for microscopic examination. The specific requirement of the prepared surface is determined by the particular type of analysis or examination. Specimens can be prepared to the perfect finish, the true structure, or the preparation can be stopped when the surface is acceptable for a specific examination.



HINT:

For further information, see the section on [Grinding and Polishing](#) on the Struers website.

2. Accessories and Consumables

Accessories

Please refer to the [Tegramin brochure](#) for details of the range available.

Specimen Holders

Please refer to the [Struers Specimen Holders brochure](#) for details of the range available.

Consumables

Please refer to the [Struers Consumables Catalogue](#).

Attaching a Cover (optional/accessory)

Struers recommended using a cover when working with alcohol-based consumables.
A Cover kit is available as an accessory.

**HINT:**

Struers offers a comprehensive range of consumables for grinding and polishing.

*The use of Struers consumables is recommended.
Other products may contain aggressive solvents, which dissolve e.g. rubber seals. The warranty may not cover damaged machine parts (e.g. seals and tubes), where the damage can be directly related to the use of non-Struers consumables.*

3. Trouble-shooting

Error Messages





Error messages are divided into two classes:
Messages
Errors

Messages





Messages are intended to inform the operator of the machine's progress and advise about minor operational errors.

Errors





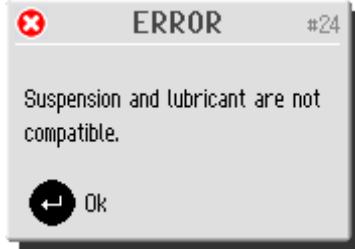

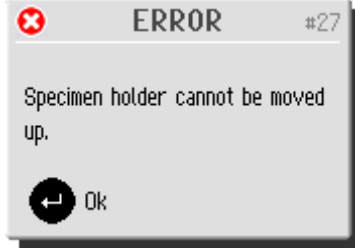
In some cases, operation cannot continue before an authorised technician has rectified the error.
Turn off the machine at the Main Switch immediately. Do not attempt to operate unit before a technician has rectified problem.
The following table gives further information on some of the Error messages that may appear.

Message	No.	Explanation	Action Required
	#0	Unspecified error.	Press Enter to acknowledge the message. Restart the machine. If the error persists, contact Struers Service. Please note the circumstances in which lead to the error.
	#1	This message is shown when the emergency stop is activated.	Message will disappear when the emergency stop button is de-activated.
	#13	The name you want to use for a group of methods exists already.	Please use a different name for the group.
	#14	The name you want to use for a method exists already.	Please use a different name for the method.





*Tegramin-25/ -30
Instruction Manual*

Message	No.	Explanation	Action Required
	#15	The name you want to use is reserved by the Tegramin.	Please use a different name.
	#19	The specimen holder head must be in the top position to continue.	Press Enter to acknowledge the message, then press ↑ to move the specimen holder head to the top position.
	#23	The method is in use and some parameters cannot be changed and some functions are unavailable.	Press Enter to acknowledge the message. Wait until the process is finished.
	#24	As user defined consumables are not divided into product groups, it is possible to combine a user defined suspension with an incompatible user defined lubricant.	Press Enter to acknowledge the message and choose a lubricant which is compatible with the selected suspension or change the lubricant type for the user-defined lubricant. This is done in the "User lubricant configuration" screen.
	#25	When creating a method, it is not possible to combine a user defined suspension with an incompatible surface.	Press Enter to acknowledge the message and choose a different suspension (or surface).
	#27	A process in specimen holder mode is finished, but due to an error in the pressure regulating system, raising the holder has failed.	Press Enter to acknowledge the message. Restart the machine. If the error persists, contact Struers Service.



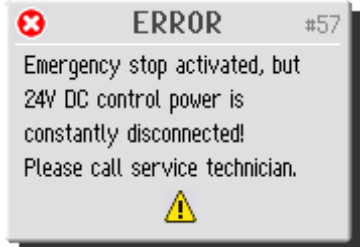
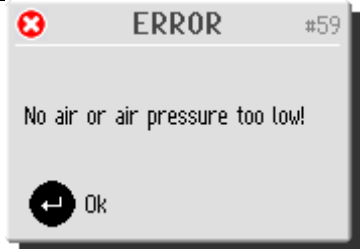

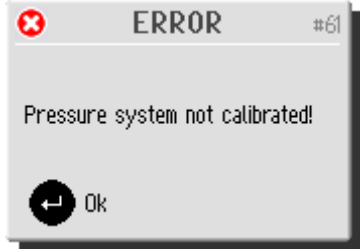
*Tegramin-25/-30
Instruction Manual*

Message	No.	Explanation	Action Required
	#28	The specimen holder cannot be lowered due to an error in the pressure regulating system.	Press Enter to acknowledge the message. Restart the machine. If the error persists, contact Struers Service.
	#35	The name you want to use for a consumable exists already.	Press Enter to acknowledge the message. Please use a different name for the consumable.
	#38		Change the operation mode to "Development" or "Configuration"
	#40	The "Level measuring in bottles" function has been set to No in the Options screen.	To activate "Level measuring in bottles": Go to the Options screen and select Yes. Then return to the Bottle configuration screen and set the actual remaining level of liquid for all the configured bottles.
	#43	Function not available in the current menu.	Press Enter to acknowledge the message. Select a method and select a step containing the consumable to be dosed.
	#47	No tubes have been selected for cleaning yet.	Press Enter to acknowledge the message. Please select the tube(s) you want to clean, then select cleaning again.

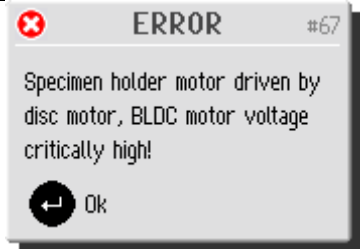
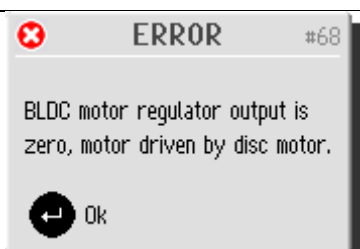

*Tegramin-25/ -30
Instruction Manual*

Message	No.	Explanation	Action Required
	#56	The emergency switch has been activated, but the 24V control power is not disconnected.	Please contact Struers Service.
	#57	The emergency switch has been activated, but the 24V control power is constantly disconnected.	Please contact Struers Service.
	#59	There is a failure in the compressed air supply.	Press Enter to acknowledge the message. Check and re-establish the compressed air supply.
	#60	There is a failure in the pressure regulator.	Check the compressed air supply and restart the machine. If the error persists, contact Struers Service.
	#61	The pressure system is not calibrated correctly.	Press Enter to acknowledge the message. Restart the machine. If the error persists, contact Struers Service.
	#64	After pressing stop or when the preparation time expired, the preparation disc did not stop.	Press Enter to acknowledge the message. Use the emergency stop to stop the disc. Restart the machine. If the error persists, contact Struers Service.

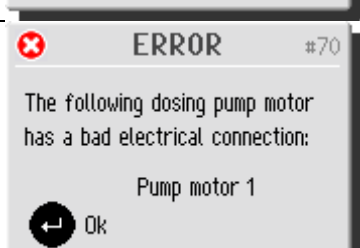

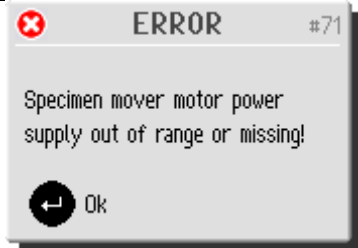
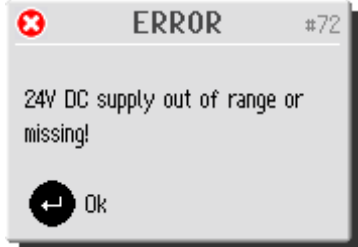
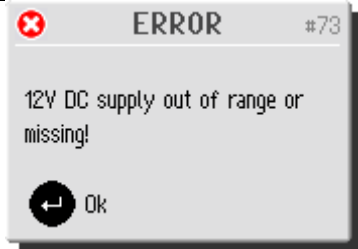
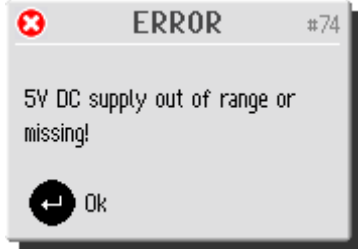

*Tegramin-25/-30
Instruction Manual*

Message	No.	Explanation	Action Required
	#65	The specimen holder motor could not be started or stopped before the preparation time expired.	Press Enter to acknowledge the message. Restart the machine. Reduce the force and start the process again. If the error persists, contact Struers Service.
	#66	The specimen holder motor is overloaded and is overheating.	Press Enter to acknowledge the message. Wait a little while to let the motor cool down, reduce the force and continue the preparation process. If this does not help, contact Struers Service.
	#67	The specimen holder motor is driven by the preparation disc.	Press Enter to acknowledge the message. Position the specimen holder more to the left (to reduce the friction force) or reduce the force and/or the disc motor speed. Press START again. If it does not help, contact Struers Service.
	#68	The specimen holder motor is driven by the preparation disc.	Press Enter to acknowledge the message. Position the specimen holder more to the left (to reduce the friction force) or reduce the force and/or the disc motor speed. Press START again. If it does not help, contact Struers Service.
	#69	The end stops of the specimen mover head are not adjusted correctly.	Press Enter to acknowledge the message. Call Struers Service.
	#70	There is no electrical connection to the pump mentioned.	Press Enter to acknowledge the message. Switch of the machine. Remove the pump module in question and slide back in position again. Restart the machine. If the error persists, contact Struers Service.



*Tegramin-25/ -30
Instruction Manual*

Message	No.	Explanation	Action Required
	#71	The power supply for the specimen mover motor is too high or too low (24 V DC +/- 10%).	Press Enter to acknowledge the message. Restart the machine. If the error persists, contact Struers Service.
	#72	24 V DC supply voltage out of 10% range. Power supply must be adjusted or exchanged.	Press Enter to acknowledge the message. Restart the machine. If the error persists, contact Struers Service.
	#73	12 V DC supply voltage out of 10% range. The PCB might be damaged.	Press Enter to acknowledge the message. Restart the machine. If the error persists, contact Struers Service.
	#74	5 V DC supply voltage out of 10% range. The PCB might be damaged.	Press Enter to acknowledge the message. Restart the machine. If the error persists, contact Struers Service.
	#80	An error in the frequency inverter is detected.	Press Enter to acknowledge the message. Check the mains supply. Restart the machine. If the error persists, contact Struers Service.
	#81	The mains supply is too high, or the frequency inverter is defective.	Press Enter to acknowledge the message. Check the mains supply. Restart the machine. If the error persists, contact Struers Service.

Tegramin-25/-30
Instruction Manual

Message	No.	Explanation	Action Required
	#82	The disc motor is overloaded, but not yet overheated.	Press Enter to acknowledge the message. Reduce the force and continue the preparation process.
	#83	The safety signal in the frequency inverter (controlled by the Tegramin PCB) has not been activated.	Press Enter to acknowledge the message. Restart the machine. If the error persists, contact Struers Service.
	#84	An error in the frequency inverter is detected. (The codes shown are refer to the frequency inverter manual.)	Press Enter to acknowledge the message. Restart the machine. If the error persists, contact Struers Service. Make a note of the error codes to assist in finding the fault.
	#87	The sensor for the cover is not activated or defective.	<p>Press Enter to acknowledge the message.</p> <p>Open and close the cover, check for possible obstacles. Restart the machine. If the error persists, contact Struers Service.</p> <p>Check that the cover is completely closed, and press START. If this does not help, call Struers Service. For models without a Safety cover, Tegramin can be operated whilst waiting for Service.</p> <p>Go to Options screen and set "Allow operation with cover open" to "Yes".</p>
	#89	Electrical output error e.g. "X-motor".	<p>Press Enter to acknowledge the message.</p> <p>Restart the machine. In certain circumstances (dependent on which module has failed) it may still be possible to operate the machine.</p> <p>If the error persists, contact Struers Service.</p> <p>Make a note of the specific output mentioned to assist in finding the fault.</p>

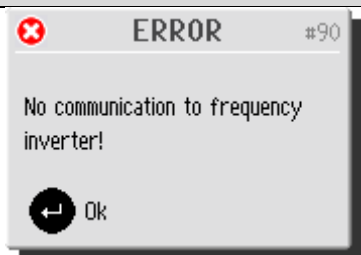
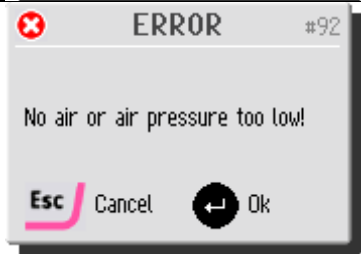
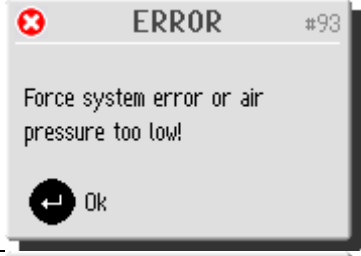
Tegramin-25/ -30
Instruction Manual

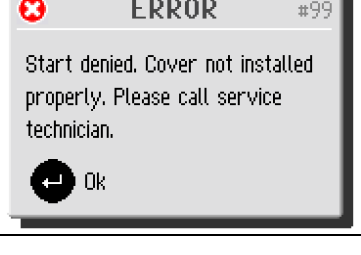
Message	No.	Explanation	Action Required
	#90		Press Enter to acknowledge the message. Restart the machine. If the error persists, contact Struers Service.
	#92	Air pressure too low to carry out "Adjustment of specimen mover plate height".	Check compressed air connection and press Enter to carry out to the adjustment. Or Press ESC to abort the adjustment.
	#93	Compressed air pressure is too low or there is a failure in the pressure regulation system.	Press Enter to acknowledge the message. Check compressed air connection (pressure should be between 6 and 10 Bar) If the error persists, contact Struers Service.
	#94	Electrical input error e.g. "BP 1".	Press Enter to acknowledge the message. The machine can be used to perform manual preparations but will be unable to perform automatic preparations. Contact Struers Service.
	#97	Malfunction of the Emergency stop.	Press Enter to acknowledge the message. Restart the machine. If the error persists, contact Struers Service. Do not attempt to operate the machine with a defective Emergency stop.
	#99	A Safety cover has been removed. A Struers Service Engineer is required to re-set the setting in the Options screen.	Contact Struers Service.

Tegramin-25/-30
Instruction Manual

Physical Observations/Problems	Explanation	Action required
Noise when the machine starts or the machine will not pull.	The belt is not tight enough.	Call Struers Service. The belt must be tightened.
Functions are not carried out.	Fuse at the rear of Tegramin blown.	Replace the fuse.
Machine not operating		
Water not draining away.	Drain hose squeezed.	Straighten the hose.
	Drain hose clogged.	Clean the hose.
	Drain hose does not slope downward.	Adjust the hose to slope evenly downwards.
Cooling water stops.	Wrong software setting.	Check software setting.
	Water tap on mains closed.	Open for water.
	Built-in water tap closed.	Open for water.
	Built-in water tap blocked.	Clean water tap.
	Filter at the water inlet blocked.	Clean filter.
Insufficient water flow of water	Built-in water tap blocked.	Clean water tap.
	Filter at the water inlet blocked.	Clean filter.
	Water valve needs to be adjusted.	See Adjusting the Water Flow .
Cooling water drips after stop.	Defect in the solenoid valve.	Call Struers Service. The solenoid valve must be replaced.
Continuous, irregular wear on a grinding/polishing surface.	Worn coupling on either specimen holder/mover plate or the specimen mover head of the Tegramin.	Please contact Struers Service to replace the coupling.
The preparation disc runs unevenly or stops.	Force too high.	Reduce the force.
The preparation disc stops.	Frequency inverter has stopped the equipment.	Switch the equipment off. Wait for a few minutes then Re-start. If error remains, contact Struers Service.
	Specimens are wider than the radius of the preparation disc.	Use smaller specimens.
Uneven specimens.	Specimens are passing over the centre of the disc.	Reposition the horizontal position of the Specimen Holder/ Specimen Mover Plate. See Adjusting the Horizontal Position of the Specimen Holder / Mover Plate Adjusting the Horizontal Position of the Specimen Holder / Mover Plate

4. Service Information

Tegramin offers extensive information about the conditions of all different components.

To reach this function:

- Go to the *Maintenance* menu and select: *Service information*.

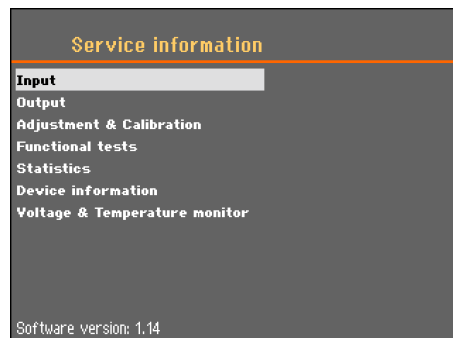

Various topics can be selected for information on the condition of the different components.

Service information can also be used in cooperation with Struers Service for remote diagnostics of the equipment.

Service information is read-only information, machine settings cannot be changed or modified.

Service Check

Stuers recommends that a regular service check be carried out yearly or after every 1500 hours of use.

Stuers offers a range of comprehensive maintenance plans to suit the requirements of our customers. This range of services is called **ServiceGuard**.

The maintenance plans include equipment inspection, replacement of wear parts, adjustments/calibration for optimal operation, and a final functional test.

Information on total operation time and servicing of the machine is displayed on the screen at start-up:



A pop-up message will appear after 1,000 hours operation time to remind the user that a service check should be scheduled.

After the 1,500 hours operation time has been exceeded the pop-up message will change to alert the user that the recommended service interval has been exceeded.

- Contact Struers Service to service the machine.

5. Spare Parts and Diagrams

Safety Related Parts of the Control System (SRP/CS)

Safety Related Part	Manufacturer / Manufacturer Description	Manufacturer Cat. no.
Safety relay	Pilz 2 ch w. 3s delay	PNOZ XV1P 3/24VDC 2n/o 1n/o t
Emergency Stop button	Schlegel Latching Mushroom Head	ES Ø22 type RV
Emergency Stop contact	Schlegel Modular Contact, momentary	1 NC type MTO
Water valve	Invensys V Series Water Valves	Solenoid valve triple 24VDC Gn.311
Frequency inverter	Omron Frequency inverter 1x200V 750W	VZAB0P7BAA
Contact relay	Omron Contactor 24VDC	J7KNG-14-01-24D
Interlock hinge ³	Pizzato, Pizzato safety hinge sw, M12	HPAB050D-KAM

Stuers' Cat. No. are listed in the Spare Parts list.



WARNING

Safety critical components are to be replaced after a maximum lifetime of 20 years.
Contact Struers Service for information.



NOTE:

Replacement of Safety critical components can only be performed by a Struers engineer or a qualified technician (electromechanical, electronic, mechanical, pneumatic, etc.).
Safety critical components may only be replaced by components with at least the same safety level.

Contact Struers Service for information.

³ For safety cover, only.

Spare Parts List

For further information, or to check the availability of other replacement parts, please contact your local Struers Service department. Contact information is available on Struers webpage.

Spare Part	Cat no:
Safety relay	2KS10007
Emergency Stop button	2SA10400
Emergency Stop contact	2SB10071
Water valve	2YM12311
Frequency inverter	2PU12075
Contactor relay	2KM71411
Interlock hinge ³	2SS48086

Diagrams

Block Diagram, Tegramin 16013052
 Air Diagram Tegramin-25/-30 16011000
 Water Diagram Tegramin-25/-30 16011001

See the following pages.

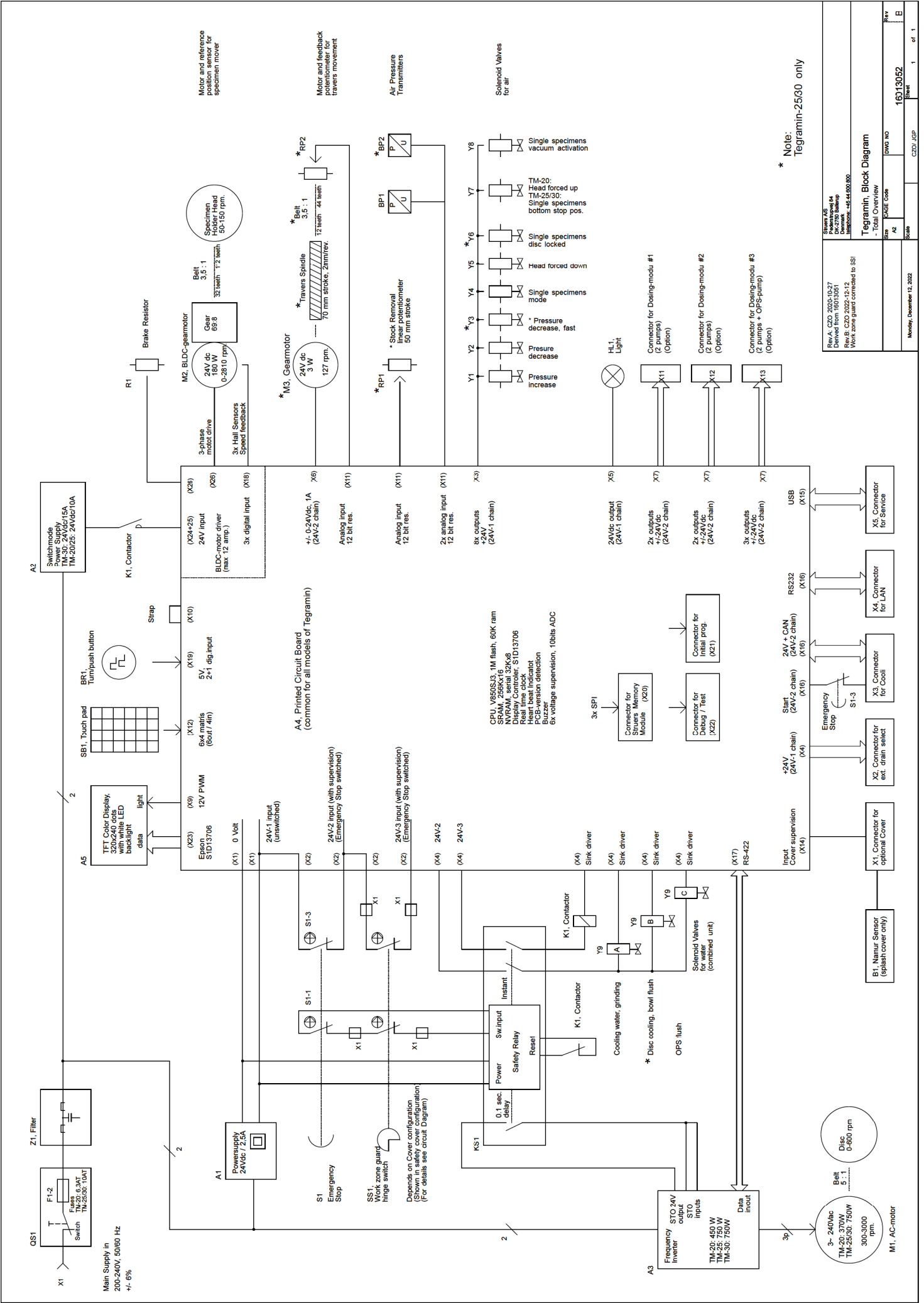

* Note:
Tegramin-25/30 only

Rev.A: CZO 2020-10-27 Derived from 16013051	Rev.B: CZO 2022-12-12 Main cover guard connected to SSI	Rev.C: CZO 2022-12-12 Main cover guard connected to SSI	Rev.D: CZO 2022-12-12 Main cover guard connected to SSI
Rev. A2	Rev. A2	Rev. A2	Rev. A2
16013052	16013052	16013052	16013052
Monday, December 12, 2022	Monday, December 12, 2022	Monday, December 12, 2022	Monday, December 12, 2022

Tegramin, Block Diagram

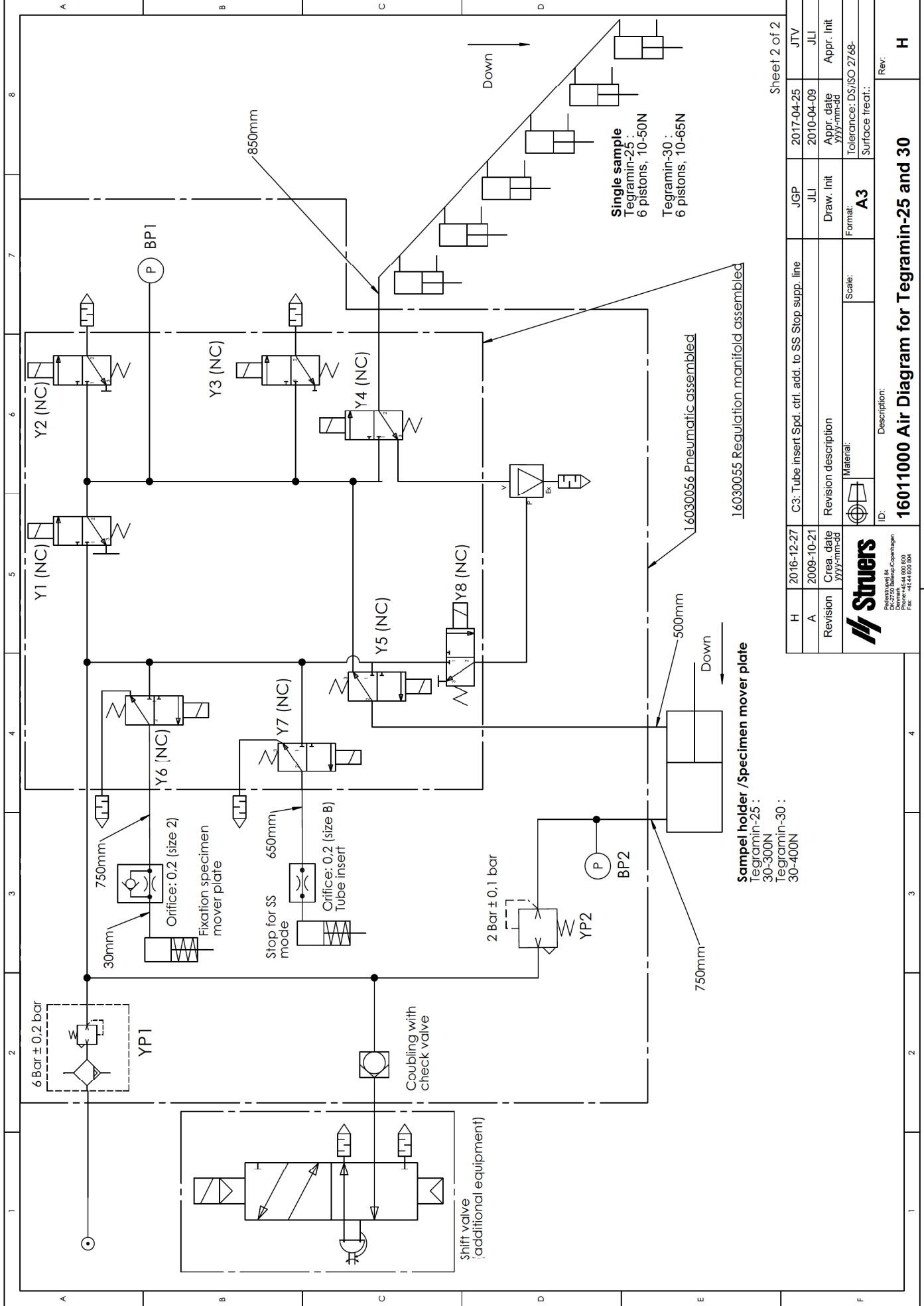

Sheet 2 of 2	
H	2016-12-27
A	2009-10-21
Revision	Creation date
	YYYY-mm-dd
Description	
C3: Tube Insert Spd. ctrl. add. to SS Stop supp. line	
Material:	
Scale:	
Format: A3	
JGP	2017-04-25
JLI	2010-04-09
Draw. Init	Appr. date
	YYYY-mm-dd
Tolerance: DS/ISO 2768-	
Surface treat.:	
ID:	
Description:	
16011000 Air Diagram for Tegramin-25 and 30	
Rev:	
H	

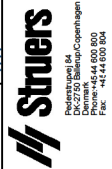

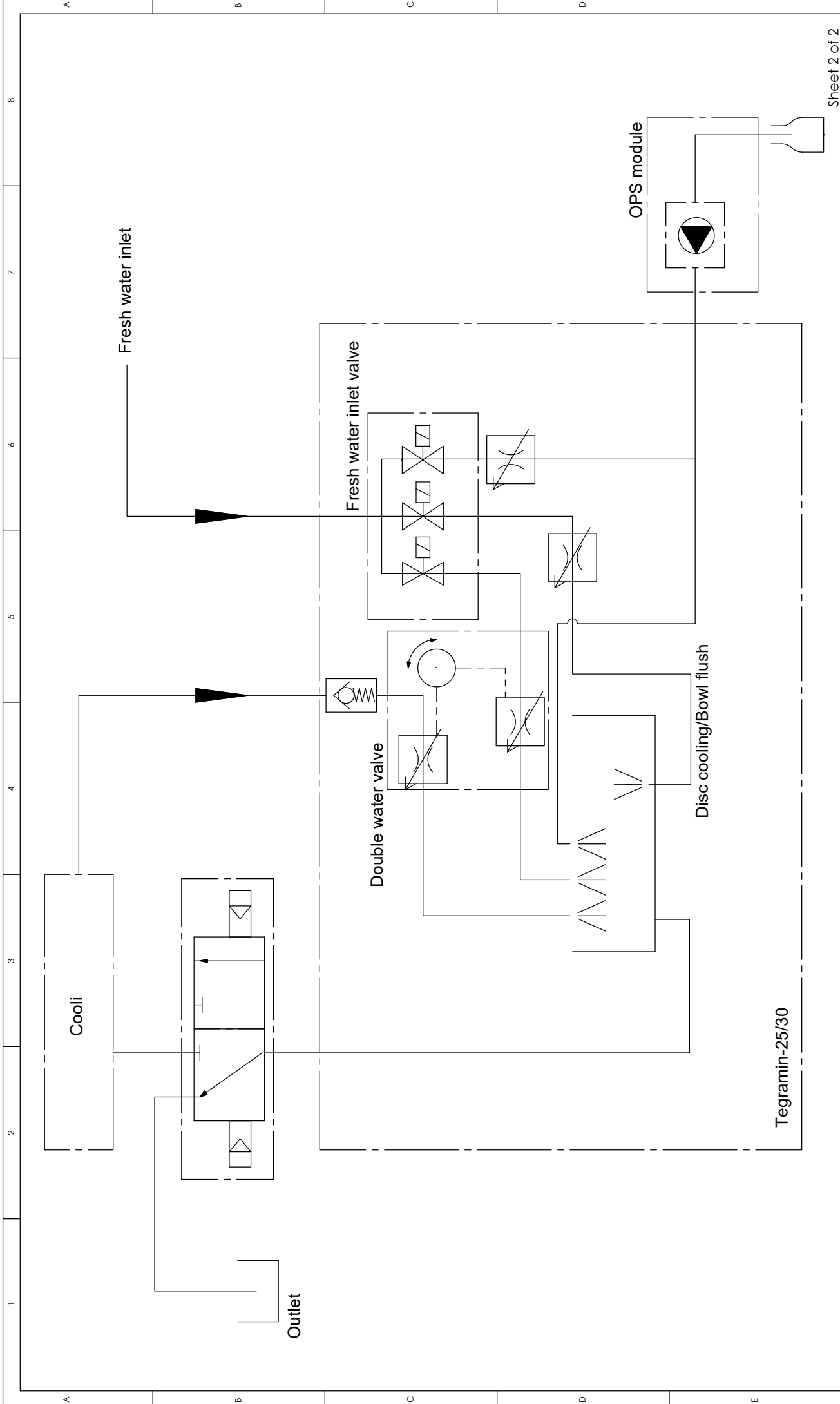

Sheet 2 of 2

D	2018-09-27	C5: Check valve rotated 180	OCR	2018-09-27	JGP
A	2010-04-09		JLI	2010-04-09	JLI
Revision	Creation date yyyy-mm-dd	Revision description	Draw. Init	Appr. date yyyy-mm-dd	Appr. Init
		Material:	Format:	Scale:	Tolerance: DS/ISO 2768- Surface treat.:
			A3	2:1	
		ID: Description: 16011001 Water diagram for Tegramin-25 and 30		Rev: D	
Pedestalsvej 84 DK-2750 Ballerup/Copenhagen Phone: +45 44 600 800 Fax: +45 44 610 804					

6. Legal and Regulatory

FCC Notice

This equipment has been tested and found to comply with the limits for a Class A digital device, pursuant to Part 15 of the FCC Rules. These limits are designed to provide reasonable protection against harmful interference when the equipment is operated in a commercial environment. This equipment generates, uses, and can radiate radio frequency energy and, if not installed and used in accordance with the Instruction Manual, may cause harmful interference to radio communications. Operation of this equipment in a residential area is likely to cause harmful interference in which case the user will be required to correct the interference at his own expense.

Pursuant to Part 15.21 of the FCC Rules, any changes or modifications to this product not expressly approved by Struers A/S could cause harmful radio interference and void the user's authority to operate the equipment.

EN ISO 13849-1:2015

All SRP/CS are limited to a lifetime of 20 years. After expiration of this period, all components must be replaced.

7. Technical Data

Subject		Specifications	
		Tegramin-25	Tegramin-30
Disc	Diameter	250 mm / 10"	300 mm / 12"
	Speed	40-600 rpm, variable	
	Rotational direction	Counter-clockwise	
	Disc motor	750 W / 1.0 HP	750 W / 1.0 HP
	Torque at disc Cont. at <300 rpm Cont. at 600 rpm Max.	23.8 Nm / 17.6 ft-lbf 11.9 Nm / 8.8 ft-lbf > 40 Nm / 29.6 ft-lbf	23.8 Nm / 17.6 ft-lbf 11.9 Nm / 8.8 ft-lbf > 40 Nm / 29.6 ft-lbf
Head	Speed	50-150 rpm, variable	
	Rotational direction	Clockwise, counter-clockwise	
	Head motor	120W (0.16 HP)	160W (0.21 HP)
	Torque	7.5 Nm / 5.6 ft-lbf	10.2 Nm / 7.6 ft-lbf
Software and electronics	Controls	Touch pad and Turn/Push knob	
	Memory	FLASH-ROM / RAM / NV-RAM	
	LC display	TFT-colour 320x240 dots with LED back light	
EU Directives		Please refer to the Declaration of Conformity	
Stop Mechanisms, Designed to comply with:	Emergency stop	EN60204-1, Stop Category 0 EN13849-1, PL=c, Category 1	
	Cover	Software control only. Not safety rated	
	Safety Cover	EN60204-1, Stop Category 0 EN13849-1, PL=c, Category 1	
Noise level⁴	A-weighted sound emission pressure level at workstations	L _{WA} = 66 dB(A) measured value Uncertainty K = 4 dB Measurements made in accordance with EN ISO 11202	
Vibration Level	During preparation	Total vibration exposure to upper parts of the body does not exceed 2.5 m/s ² .	

⁴ Noise level: The figures quoted are emission levels and are not necessarily safe working levels. While there is a correlation between the emission and exposure levels, this cannot be used reliably to determine whether or not further precautions are required. Factors that influence the actual level of exposure of the workforce include characteristics of the work room, the other sources of noise, etc., i.e. the number of machines and other adjacent processes. Also, the permissible exposure level can vary from country to country.



*Tegramin-25/-30
Instruction Manual*

Subject		Specifications	
		Tegramin-25	Tegramin-30
Operating environment	Surrounding temperature	5-40°C / 41-104°F	
	Humidity	0 – 90% RH (Non condensing)	
Storage Conditions		-25 – 55°C / -13 – 131°F	
Supply	Voltage / frequency	200-240 V / 50-60 Hz	
	Power inlet	1-phase (N+L1+PE) or 2-phase (L1+L2+PE) The electrical installation must comply with "Installation Category II".	
	Power, nominal load	1060 W	1060 W
	Power, idle	13 W	13 W
	Current, nom.	5.3 A	5.3 A
	Current, max.	10 A	10 A
	Pressure for tap water	1-10 bar / 14.5-145 psi	
	Water inlet	¾" dia.	
	Water outlet	40 mm / 1 ½" dia.	
	Air inlet	6 mm / ¼" dia.	
	Air pressure	6-10 bar / 87-145 psi	
	Air flow	3.5-4 l/min	
	Air quality	Recommended quality: ISO 8573-1, class 5.6.4.	
"Exhaust" (with Cover only)	Dimension	50 mm / 2" dia. Recommended capacity for exhaust system: 50m³/h / 1750ft³/h at 0mm water gauge.	
Dimensions and weight (without Cover)	Width	67.5 cm / 26.6"	67.5 cm / 26.6"
	Depth	75 cm / 29.5"	75 cm / 29.5"
	Height	56 cm / 22.0"	56 cm / 22.0"
	Weight	90 kg / 198 lbs	90 kg / 198 lbs
Dimensions and weight (with Cover)	Width	67.5 cm / 26.6"	67.5 cm / 26.6"
	Depth	75 cm / 29.5"	75 cm / 29.5"
	Height (cover closed/ cover open)	58.2 cm / 22.9" 90 cm / 35.4"	58.2 cm / 22.9" 90 cm / 35.4"
	Weight	98 kg /216 lbs	98 kg /216 lbs
Dimensions and weight (with Safety cover)	Width	67.5 cm / 26.6"	67.5 cm / 26.6"
	Depth	75 cm / 29.5"	75 cm / 29.5"
	Height (cover closed/ cover open)	58.2 cm / 22.9" 90 cm / 35.4"	58.2 cm / 22.9" 90 cm / 35.4"
	Weight	98 kg /216 lbs	98 kg /216 lbs

Tegramin, Pre-Installation Checklist

Read the Installation instructions in the Instruction Manual *before* installing the machine.

Installation Requirements

- Crane and 2 lifting straps¹
- Screwdriver/ bit: TX30 , PH2  and H4 

Required Accessories and Consumables
(ordered separately)

(Please refer to the [Tegramin Brochure](#) and the [Struers Consumables Catalogue](#) for details of the range available.).

Recommended

Exhaust system: 50 m³/h / 1750 ft³/hat 0 mm/0" water gauge (Tegramin with Cover / Safety cover)

Recirculation cooling unit

Crating Specifications

Tegramin-20

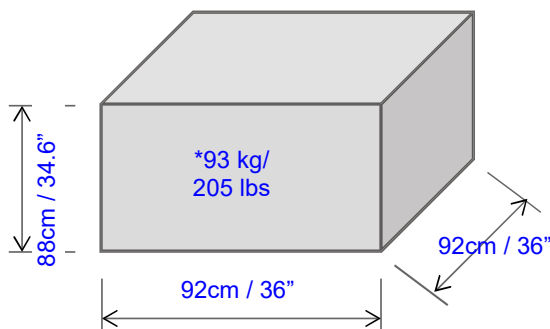

Tegramin-25/-30

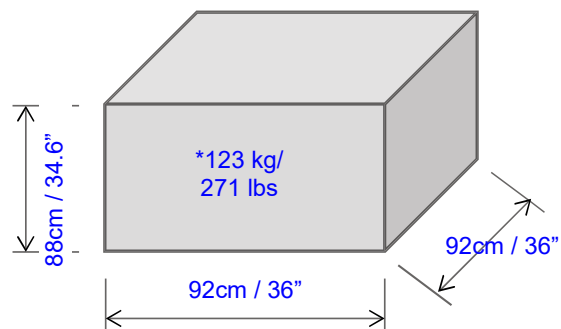

*For Tegramin with cover and safety cover, add 8 kg / 17 lbs

¹ Straps must be approved of at least twice the weight of the machine.

Unpacking

- Carefully open and remove the sides and the top of the packing crate.
- Remove the transport brackets securing the machine to the pallet.

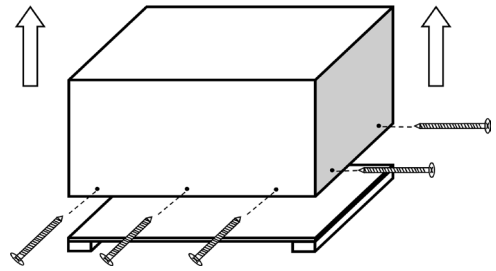

Location

- The machine must be placed close to the power supply.
- The machine is designed to be placed on a rigid, stable workbench with a horizontal surface.

Recommended dimensions:

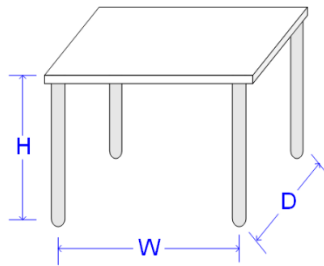

Height: Recommended 80 cm / 31.5"
Width: 92 cm / 36.2"
Depth: 90 cm / 35.4"

Recommended workbench dimensions. Height of table (H) follows local preferences.

- To facilitate easy access for service technicians, allow sufficient space around the machine.
- The machine must be placed close to power supply and close to a drain / Recirculation cooling unit.



HINT:

A table unit designed for Struers' table top machines is available as an accessory Cat. No. 06266101. The Recirculation cooling unit fits into a compartment in the table unit

Recommended Space

Front: Recommended space at the front: 100 cm / 40".

Rear: The machine may be placed against a wall.

- Check there is enough room behind the table for the inlet and outlet hoses. (No extra space is required when using Struers table as the table top has pre-cut holes for the hoses).
- Check there is enough room behind the table for the cover to be opened fully (see illustration on page 92).
- Check there is approx. 15 cm / 5.9" behind the machine for the exhaust hose.

Sides: A bottle tray and/or Tegramin can be placed on either side of the Tegramin.
Recommended space at side for a bottle tray: 22 cm / 8.7".
Recommended space at side for a Tegramin: 40 cm / 16".

Dimensions

Tegramin-20

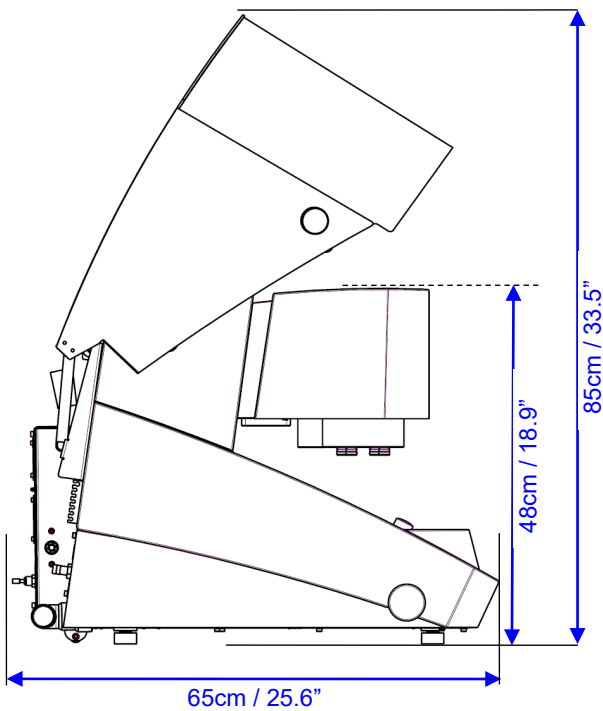

Tegramin-25/-30

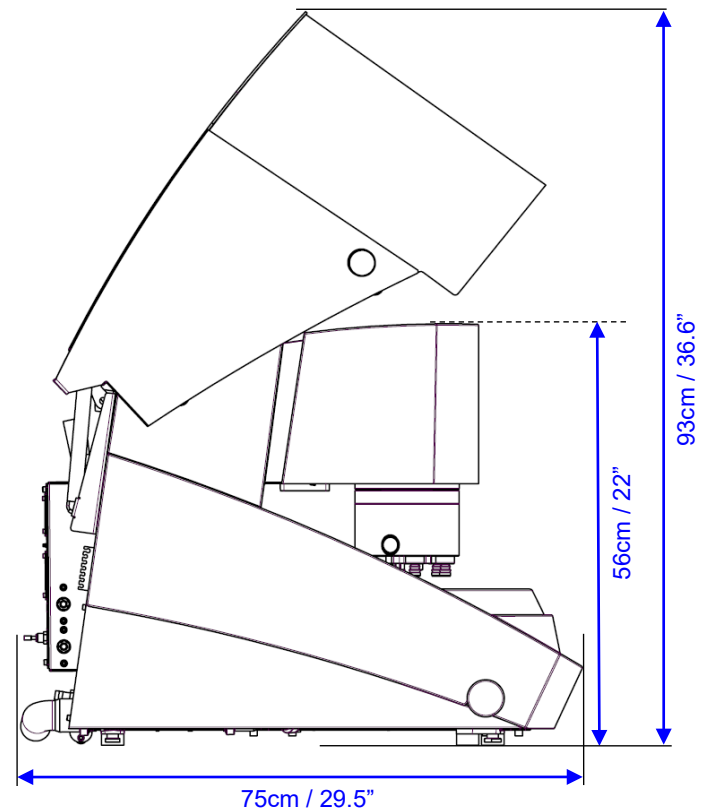

Tegramin, Pre-Installation Checklist

Footprint (feet)
Tegramin-20

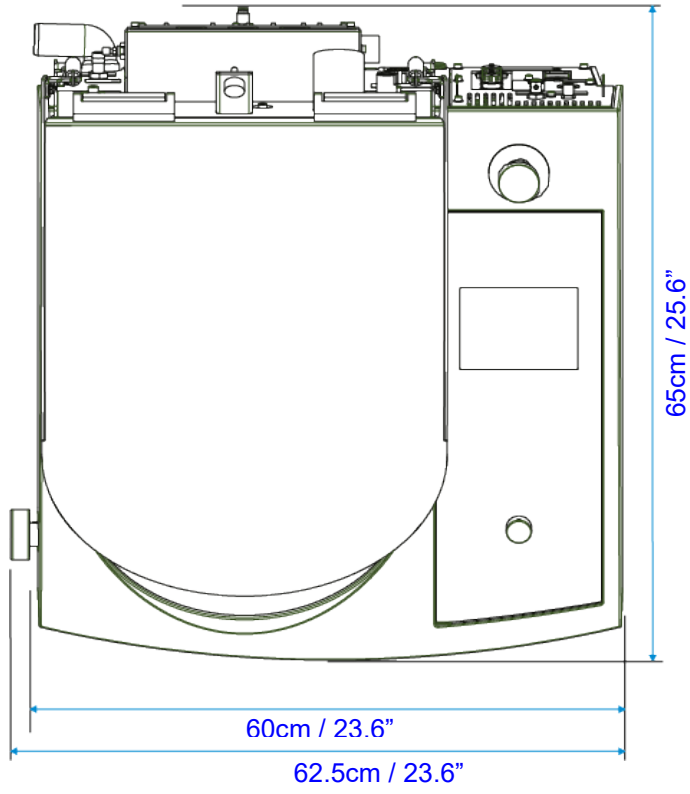

Footprint (feet):
Tegramin-25/-30

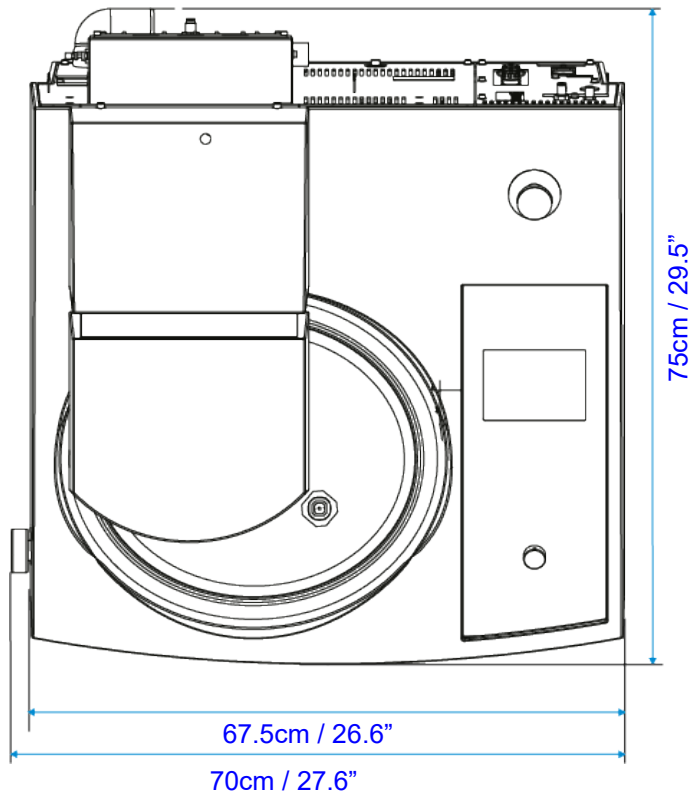

Lifting



NOTE:

Do not lift Tegramin using the light grey body.
Always lift from underneath the machine.

With a crane

A crane and 2 lifting straps are required to lift the machine off the shipment pallet.

A lifting bar is recommended so that the two straps are kept apart below the lifting point.

Tegramin with Cover / Safety cover - Use straps which are long enough so that they do not place stress on the cover (use straps of approx. 3-3½ m in length).

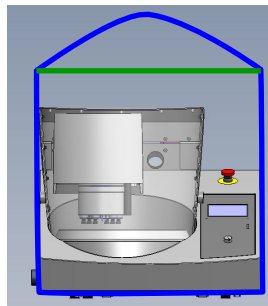

*Tegramin with Cover / Safety cover:
Ensure that the lifting straps are held
away from the top cover*

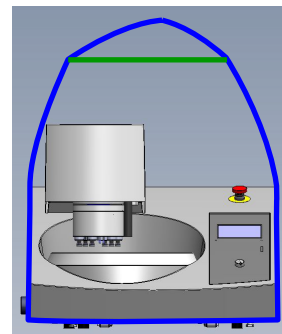

Tegramin without cover:

- Place the two lifting straps under Tegramin.
 - Position the straps under Tegramin, so that they are on the outer side of the feet.

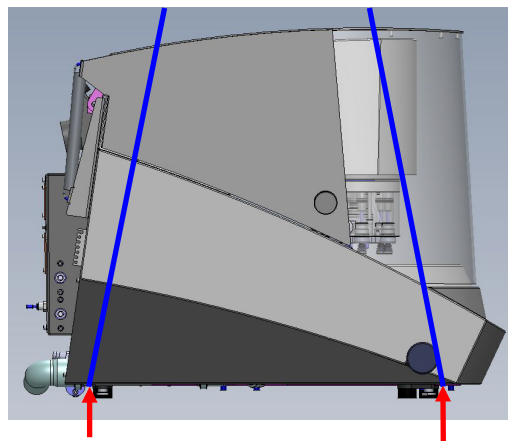

Position straps here

Position straps here

- Lift Tegramin onto the table.
- Lift the front of Tegramin and carefully move into place using the rollers.

Power Supply

The machine shipped with 2 types of Mains cables (length 2.5 m/ 8.2').

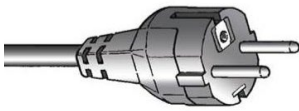

The 2-pin (European Schuko) plug is for use on single-phase connections. If the plug supplied on this cable is not approved in your country, then the plug must be replaced with an approved plug.

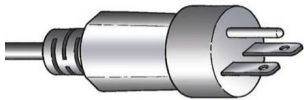

The 3-pin (North American NEMA 6-15P) plug is for use on 2-phase connections. If the plug supplied on this cable is not approved in your country, then the plug must be replaced with an approved plug.

Electrical data

	Tegramin-20	Tegramin-25	Tegramin-30
Voltage / frequency	200-240 V / 50-60 Hz		
Power inlet	1-phase (N+L1+PE) or 2-phase (L1+L2+PE) The electrical installation must comply with "Installation Category II".		
Power, nominal load	680 W	1060W	1060W
Power, idle	9 W	13W	13W
Current, nom.	3.4 A	5.3 A	5.3 A
Current, max.	6.3 A	10 A	10 A

Safety Functions

Stop Mechanisms

	Designed to comply with a minimum of
Emergency stop	EN60204-1, Stop Category 0 EN13849-1, PL= c , Category 1
Cover	Software control only. Not safety rated
Safety Cover	EN60204-1, Stop Category 0 EN13849-1, PL= c , Category 1

Water Supply

Required

Option

Water Pressure: 1-10 bar / 14.5 -145 psi

Hose supplied: ¾" water inlet hose x 2 m / 6.5' with standard connector, filter gasket and reduction ring ¾" to ½"

Tube Connection: ¾" British Standard pipe thread

Water for wet grinding may be supplied from the water mains or a Recirculation Cooling Unit.
See Accessories on page 97 for details.



HINT:

With new water pipe installations, leave the water to run for a few minutes to flush any debris from the pipe, before connecting to Tegramin.

Water outlet – Drain

Required

Option

The machine is supplied with a 1.2 m / 4.9' water outlet hose.
Ensure that the water outlet drain is below the level of the machine.

Compressed air

Required

Option

Connector supplied: Connection piece – 6 mm dia. hose to ⅛" quick coupling

Pressure: 6-10 bar / 87 -145 psi

Flow: 3.5-4 l/min

Recommended quality: ISO 8573-1, class 5.6.4.

Exhaust

Required

Option

Recommended (Tegramin with Cover / Safety cover) Minimum capacity: 50 m³/h / 1750 ft³/h at 0 mm / 0" water gauge.

Exhaust connection: 50 mm / 2" connection on the rear of the machine, on the cover/safety cover bracket.

Ambient Conditions



5 - 40 °C
41 - 104 °F



Max. 90 % RH non condensing

Accessories & Consumables

Please refer to the [Tegramin Brochure](#) and the [Struers Consumables Catalogue](#) for details of the range available.

Recirculation cooling unit

Option

Recommended:

- *Struers Cooling System 3* (Cat. No. 05766xxx) with 50 l tank, small pump, Cooli-1 and static filter.
- *Struers Corrozip*, Additive for recirculation cooling unit, to prevent corrosion.

The Recirculation Cooling Unit is supplied with a 2.5 m / 8.2' water hose and a GEKA connection for easy assembly.

The Recirculation Cooling System is supplied with a 2.5 m/ 8.2' power cable to connect to a **single phase** mains power supply.



NOTE:

When connecting Tegramin to both mains water AND the recirculation cooling unit you also must install the shift valve for the drain. Failure to do this may result in emptying or overflowing the recirculation cooling unit.

Consumables

The use of Struers consumables is recommended.

Other products (e.g. coolants) may contain aggressive solvents, which dissolve e.g. rubber seals. The warranty may not cover damaged machine parts (e.g. seals and tubes), where the damage can be directly related to the use of non-Struers consumables.

Declaration of Conformity

Manufacturer	Struers ApS • Pederstrupvej 84 • DK-2750 Ballerup • Denmark
Name	Tegramin-20 Tegramin-25 Tegramin-30
Model	N/A
Function	Grinding/polishing machines
Type	601, 602, 603
Cat. no.	06016127, 06026127, 06016227, 06026227, 06016327, 06036127, 06016427, 06036227 In combination with: 06016905, 06036910, 06026905, 06036904, 06036905, 06016906, 06036900, 06036906, 06036901, 06016903, 06036902 06036903
Serial no.	



Module H, according to global approach



We declare that the product mentioned is in conformity with the following legislation, directives and standards:

2006/42/EC	EN ISO 12100:2010, EN ISO 13849-1:2015, EN ISO 13849-2:2012, EN ISO 13850:2015, EN 60204-1:2018, EN 60204-1-2018/Corr.:2020
2011/65/EU	EN 63000:2018
2014/30/EU	EN 61000-3-2:2014, EN 61000-3-3:2013, EN 61000-6-2:2005, EN 61000-6-2:2005/Corr.:2005, , EN 61000-6-3:2007, EN 61000-6-3-A1:2011, EN 61000-6-3-A1-AC:2012
Additional standards	NFPA 79, FCC 47 CFR Part 15 Subpart B

Authorized to compile technical file/
Authorized signatory

Date: [Release date]

Declaration of Conformity

Manufacturer	Struers ApS • Pederstrupvej 84 • DK-2750 Ballerup • Denmark
Name	Tegramin-30 with safety cover Tegramin-25 with safety cover
Model	N/A
Function	Grinding/Polishing machine
Type	602, 603
Cat. no.	06026527, 06036527 In combination with: 06016905, 06036902, 06026905, 06036910, 06036905, 06036904, 06036900, 06016906, 06036901, 06036906
Serial no.	



Module H, according to global approach



We declare that the product mentioned is in conformity with the following legislation, directives and standards:

2006/42/EC	EN ISO 12100:2010, EN ISO 13849-1:2015, EN ISO 13849-2:2012, EN ISO 13850:2015, EN ISO 14119:2013, EN ISO 14120:2015, EN 60204-1:2018, EN 60204-1-2018/Corr.:2020,
2011/65/EU	EN 63000:2018
2014/30/EU	EN 61000-3-2:2014, EN 61000-3-3:2013, EN 61000-6-2:2005, EN 61000-6-2:2005/Corr.:2005, EN 61000-6-3:2007, EN 61000-6-3-A1:2011, EN 61000-6-3-A1-AC:2012
Additional standards	NFPA 79, FCC 47 CFR Part 15 Subpart B

Authorized to compile technical file/
Authorized signatory

Date: [Release date]



Pederstrupvej 84
DK-2750 Ballerup
Denmark