

TargetX

Instruction Manual

Original Instructions



CE

Doc. no.: 15757026-01_A_en
Date of release: 2021.02.12

Copyright

The contents of this manual are the property of Struers ApS. Reproduction of any part of this manual without the written permission of Struers ApS is not allowed.

All rights reserved. © Struers ApS 2021.02.12.

Table of Contents

1	About this manual	5
2	Safety	5
2.1	Intended use	5
2.1.1	TargetX safety precautions	5
2.2	Safety messages	6
2.3	Safety messages in this manual	7
3	Getting started	7
3.1	Device description	7
3.2	TargetX - Front view	8
3.2.1	Base plate	8
3.2.2	Setup station	8
4	Transport and storage	9
4.1	Transport	9
4.2	Long-term storage or shipping	9
5	Installation	9
5.1	Unpacking	9
5.2	Checking the packing list	10
5.3	Lifting	10
5.4	Location	10
5.5	Power supply	11
5.5.1	Single-phase supply	11
5.5.2	2-phase supply	11
5.5.3	Cable installation	12
5.5.4	Cable connection	12
5.6	Mounting the base plate	12
5.7	Mounting the base plate with tape	13
5.8	Additional alignment	13
5.9	Vertical alignment of TargetGrip in the setup station sledge	14
6	Noise	14
7	Vibration	15
8	Preparing the device	15
8.1	Starting the machine the first time	15
8.2	Control panel functions - TargetX	15
8.3	Configuration - TargetX	16

8.3.1 Display contrast	17
8.3.2 Changing the measurement unit	17
8.3.3 Language	17
9 Operating the device	18
10 Maintenance and service - TargetX	19
10.1 General cleaning	19
10.2 Daily	20
10.3 Weekly	20
10.4 Spare parts	20
10.5 Service and repair	20
10.6 Disposal	21
11 Technical data	21
11.1 Technical data - TargetX	21
11.2 Diagrams	22
11.2.1 Diagrams - TargetX	22
11.3 Legal and regulatory information	25
12 Manufacturer	25
Declaration of Conformity	26

1 About this manual

Instruction Manuals

Struers equipment must only be used in connection with and as described in the instruction manual supplied with the equipment.



Note

Read the instruction manual carefully before use.



Note

If you wish to view specific information in detail, see the online version of this manual.

2 Safety

2.1 Intended use

TargetX is a setup station intended to be used in combination with TargetMaster.

The machine is for use in a professional working environment (e.g. a materialographic laboratory).

The equipment is designed to be used only with Struers consumables specifically designed for this purpose and this type of machine.

The device is designed to detect and measure the distance to hidden (internal) targets. TargetX comes with a console and a setup station, which is placed in a suitable X-ray device. TargetX is operated from the console.

The machine must be operated only by skilled/trained personnel.

Do not use the machine for the following Do not use the machine with non-compatible accessories or consumables.

Model TargetX

2.1.1 TargetX safety precautions



Read carefully before use

1. Ignoring this information and mishandling of the equipment can lead to severe bodily injuries and material damage.
2. The operator must read the safety precautions and Instruction Manual, as well as relevant sections of the manuals for any connected equipment and accessories.

3. Struers equipment must only be used in connection with and as described in the instruction manual supplied with the equipment.
4. If the equipment is subjected to misuse, incorrect installation, alteration, neglect, accident or incorrect repair, Struers will accept no responsibility for damage to the user or the equipment.
5. Dismantling of any part of the equipment, during service or repair, should always be performed by a qualified technician (electromechanical, electronic, mechanical, pneumatic, etc.).

2.2 Safety messages

Signs used in safety messages

Struers uses the following signs to indicate potential hazards.



ELECTRICAL HAZARD

This sign indicates an electrical hazard which, if not avoided, will result in death or serious injury.



DANGER

This sign indicates a hazard with a high level of risk which, if not avoided, will result in death or serious injury.



WARNING

This sign indicates a hazard with a medium level of risk which, if not avoided, could result in death or serious injury.



CAUTION

This sign indicates a hazard with a low level of risk which, if not avoided, could result in minor or moderate injury.



CRUSHING HAZARD

This sign indicates a crushing hazard which, if not avoided, could result in minor, moderate or serious injury.

General messages



Note

This sign indicates that there is a risk of damage to property, or a need to proceed with special care.



Hint

This sign indicates that additional information and hints are available.

2.3 Safety messages in this manual



CAUTION

Struers equipment must only be used in connection with and as described in the instruction manual supplied with the equipment.



ELECTRICAL HAZARD

The machine must be earthed (grounded).
Make sure that the actual electrical power supply voltage corresponds to the voltage stated on the type plate of the machine.
Incorrect voltage can damage the electrical circuit.



CRUSHING HAZARD

Take care of your fingers when handling the machine.
Wear safety shoes when handling heavy machinery.



ELECTRICAL HAZARD

Switch off the electrical power supply before installing electrical equipment.
The machine must be earthed (grounded).
Make sure that the actual electrical power supply voltage corresponds to the voltage stated on the type plate of the machine.
Incorrect voltage can damage the electrical circuit.



CAUTION

Risk of hand to arm vibration during manual preparation.
Prolonged exposure to vibration may cause discomfort, joint damage or even neurological damage.



WARNING

Do not use the machine with defective safety devices.
Contact Struers Service.



WARNING

Safety critical components must be replaced after a maximum lifetime of 20 years.
Contact Struers Service.

3 Getting started

3.1 Device description

TargetX is designed for identifying and measuring the distance to hidden targets in specimens for mechanical target preparation.

TargetX is intended to be used in combination with a X-ray chamber. The X-ray chamber enable the user to view hidden targets for preparation in a specimen. TargetX is then used to measure the

distance to the target or targets. The measurement values are afterwards used for target preparation with TargetMaster.

3.2 TargetX - Front view



- A Display
- B Control panel

3.2.1 Base plate

Base plate mounted in x-ray chamber

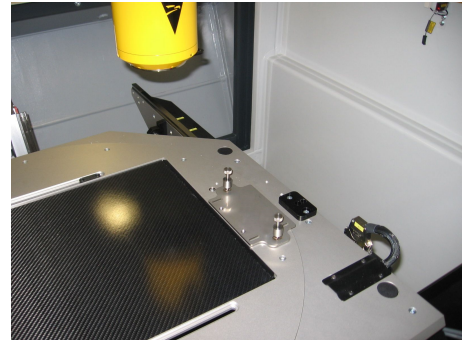

3.2.2 Setup station

- A Motor to adjust horizontal position - TargetGrip in x-plane (movement left and right on x-ray monitor)
- B Horizontal adjustment screw
- C Setup station sledge
- D Spring-loaded screws
- E Motor to tilt the sample to align the target plane with the reference edge (this adjusts the tilt mechanism in TargetGrip)
- F Motor lock-in wheel
- G Drive shaft for tilt mechanism
- H Dovetail connector - TargetGrip
- I Holes for mounting base plate
- J Base plate for installation in x-ray chamber
- K Locking knob for dovetail connector
- L Spring-loaded screws

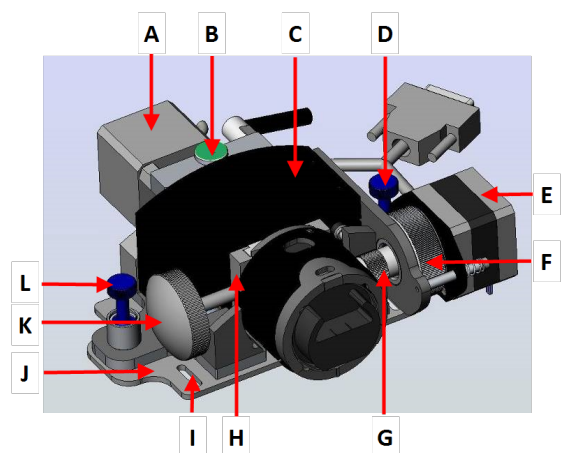

4 Transport and storage

If, at any time after the installation, you have to move the unit or place it in storage, there is a number of guidelines we recommend that you follow.

- Package the unit securely before transportation.
Insufficient packaging could cause damage to the unit and will void the warranty. Contact Struers Service.
- Struers recommends that all original packaging and fittings are kept for future use.

4.1 Transport

- Disconnect the unit from the electrical power supply.
- Lift the machine onto a stable surface.

4.2 Long-term storage or shipping

**Note**

Struers recommends that all original packaging and fittings are kept for future use.

- Remove any other accessories.
- Clean and dry the unit before storage.
- Disconnect the unit from the electrical power supply.
- Place the machine and accessories in their original packaging.

5 Installation

**WARNING**

Struers equipment must only be used in connection with and as described in the instruction manual supplied with the equipment.

5.1 Unpacking

**Note**

Struers recommends that all original packaging and fittings are kept for future use.

1. Cut the packing tape on the top of the box.
2. Remove the loose parts.
3. Remove the unit from the box.

5.2 Checking the packing list

The packing box contains the following items:

Pcs.	Description
1	Control unit
1	Setup station (mounted on base plate)
2	Power cables
1	Allen key
1	Allen screwdriver

5.3 Lifting



CRUSHING HAZARD

Take care of your fingers when handling the machine.
Wear safety shoes when handling heavy machinery.



Note

Always lift the machine from beneath.

Weight	
TargetX	13 kg (28.6 lbs)

5.4 Location



CRUSHING HAZARD

Take care of your fingers when handling the machine.
Wear safety shoes when handling heavy machinery.

- The machine must be placed close to the electrical power supply, main water supply and waste water drain.
- To facilitate easy access for service technicians, allow sufficient space around the machine.
- Place the machine on a rigid, stable workbench with a horizontal surface and an adequate height.
- Place the device so that you can observe the movements on the x-ray monitor while you adjust the controls on the control unit.



**Note**

TargetX is supplied with at 5 m (16 ft) connection cable, but you can use an additional connection cable if necessary.

5.5 Power supply

**ELECTRICAL HAZARD**

Switch off the electrical power supply before installing electrical equipment. The machine must be earthed (grounded). Make sure that the actual electrical power supply voltage corresponds to the voltage stated on the type plate of the machine. Incorrect voltage can damage the electrical circuit.

**Note**

An autotransformer is required in countries with a 110 V electrical power supply.

Power socket

The electrical power supply socket must be easy to access. The electrical power supply socket must be located at a height ranging from 0.6 m to 1.9 m (2½' to 6') above floor level. Not higher than 1.7 m (5' 6") is recommended.

**Note**

The equipment is shipped with 2 types of electrical power cables. If the plug supplied on these cables is not approved in your country, the plug must be replaced with an approved plug.

5.5.1 Single-phase supply

Single-phase supply

The 2-pin plug (European Schuko) is for use on single-phase electrical power connections.

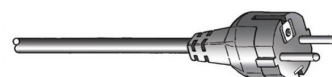

The leads must be connected as follows:

Yellow/Green	Earth (ground)
Brown	Line (live)
Blue	Neutral

5.5.2 2-phase supply

The 3-pin plug (North American NEMA) is for use on 2-phase electrical power connections.

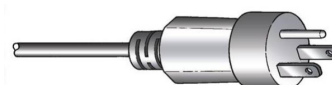

The leads must be connected as follows:

Green	Earth (ground)
Black	Line (live)
White	Line (live)

5.5.3 Cable installation

1. Lead the connection cable into the x-ray chamber through the x-ray trap. Follow the instructions indicated in the documentation for the x-ray machine.

5.5.4 Cable connection

1. Connect one end of the connection cable to the setup station.
2. Connect the other end to the TargetX control unit.

 **Note**
Align the setup station on two axes before you start using it.

5.6 Mounting the base plate

The base plate ensures that the setup station always is positioned correctly inside your x-ray device.

 **Note**
Before you mount the base plate, make sure of the following:

- The setup station is located so that you can see both the reference edge and target.
- The reference edge is aligned with the vertical crosshair.

1. Place the base plate on the side of the x-ray manipulation table which is closest to the point of entry of the connection cable.
2. Align the base plate with the edge of the table.
3. Slide the setup station on the base plate until the conical feet slot into place on the base plate.
4. Use the two-spring loaded screws to lock the setup station to the base plate.
5. Switch on the x-ray and make sure that the reference edge is visible on the monitor. If not, reposition the base plate with the setup station.

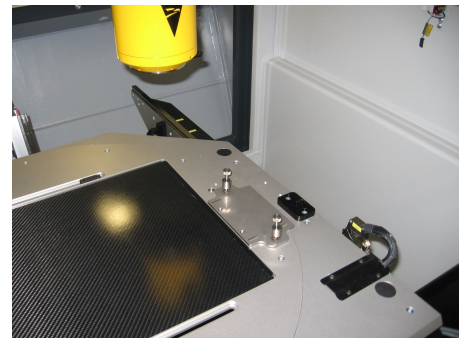

6. Use the x-ray manipulation table controls to move the reference edge into the desired position.
7. Use the TargetX control unit to move the reference edge until it is as close as possible to being parallel to the vertical crosshair of the x-ray.
8. Align the base plate, so that the reference edge is centered around the vertical crosshair of the x-ray monitor, and the reference edge is perfectly plane-parallel with the vertical crosshair.
9. Remove the setup station and mark the base plate position of the center of the elongated holes with a water-resistant pen.
10. Remove the base plate and drill holes in the marked positions.
11. Secure the base plate with four suitable screws.
12. Re-install the setup station.
13. Secure the connection cables with cable ties to prevent the setup station from being pulled out of position.



5.7 Mounting the base plate with tape

You can also use a thin, double-adhesive tape to secure the base plate.

5.8 Additional alignment

If additional alignment is required, follow these steps:

1. Turn the table until the reference is plane-parallel with the vertical crosshair.
2. Note the position (x degrees) for future use.
3. Make sure that the table is in this position when you use TargetX.



Note

Before you start the measuring process with TargetX, the reference edge must always be plane-parallel with the vertical crosshair of the x-ray monitor.



Note

Always make sure that the reference edge meets the alignment plane exactly at the horizontal crosshair before starting a measurement.

5.9 Vertical alignment of TargetGrip in the setup station sledge

The reference edge and the alignment plane on TargetGrip must be in perfect alignment to the x-ray source. Make sure that they meet exactly at the vertical crosshair. If needed, open the x-ray door, adjust, close the door, start the x-ray, use the TargetX control unit, and repeat this several times while you carry out the following alignment procedure:

1. Locate the reference edge and the alignment plane on TargetGrip.
2. Use the monitor of the x-ray machine to look at the TargetGrip. Use the TargetX controls to position the reference edge.
3. If the alignment plane is not visible, turn the adjustment screw until the pin comes into view.
4. Turn the adjustment screw in the other direction to tilt TargetGrip until the alignment plane just disappears from view.



Note

When the alignment plane is no longer visible, stop adjusting the vertical alignment screw.

5. If the reference edge is no longer aligned with the vertical crosshair, use the TargetX control unit buttons to reposition the reference edge at the vertical crosshair.
6. Turn the adjustment screw to adjust the tilt until the alignment plane just disappears from view.
7. Repeat these two steps until both the reference edge and the alignment plane are aligned with the horizontal crosshair.

TargetX is now aligned vertically with the x-ray source.

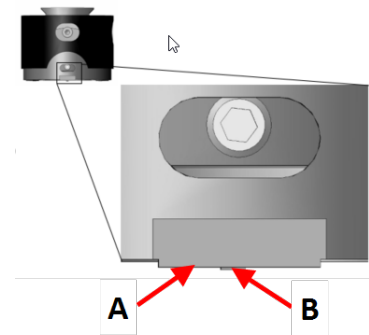

- A Reference edge
- B Alignment plane

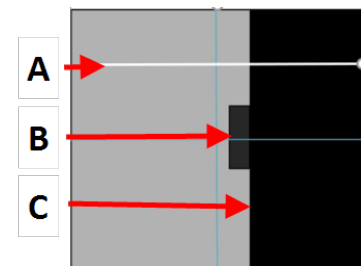

(TargetGrip as seen on x-ray monitor)

- A Digital crosshair
- B Alignment plane
- C Reference edge

6 Noise

For information on the sound pressure level value, see this section: [Technical data - TargetX ▶ 21](#)

7 Vibration

For information on the total vibration exposure to hand and arm, see this section: [Technical data - TargetX ▶ 21](#)

8 Preparing the device

8.1 Starting the machine the first time

- Switch on the machine on the main switch on the back of the machine.

Start-up - the first time

The first time the machine is switched on, the **MAIN MENU** screen is shown.

Navigating in the display: See [Control panel functions - TargetX ▶ 15](#)

Language

Select the language you wish to use. If needed, you can change the language at a later date.

1. From the **MAIN MENU** screen, select **CONFIG. > Language**.
2. Scroll up or down in the list to select the language of your choice.









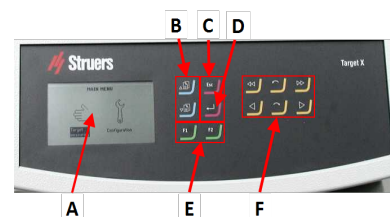



Start-up - daily operation

When you switch on the machine, the screen that was shown when the machine was switched off is shown just after the start-up screen.

8.2 Control panel functions - TargetX

- A Display
- B Scroll down/Scroll up
- C Escape
- D Enter
- E Function keys
- F Arrow buttons



Button	Function
 to 	Function key <ul style="list-style-type: none"> Press this button to activate controls for various purposes. See the bottom line of the individual screens.
	Scroll up <ul style="list-style-type: none"> Press this button to scroll up in a screen and to increase the value of a setting.
	Scroll down <ul style="list-style-type: none"> Press this button to scroll down in a screen and to decrease the value of a setting.
	Escape Use this button on the control panel to return to previous functions or values. <ul style="list-style-type: none"> Press the button to return to the main menu. Press the button to return to the last function or value. Press the button to cancel changes.
	Select/Enter <ul style="list-style-type: none"> Press this button to enter a field, for instance a setting, to select a value, and to confirm a selection.
	Move quickly to the left
	Move quickly to the right
	Tilt to the left
	Tilt to the right
	Move to the left
	Move to the right

8.3 Configuration - TargetX

- From the **Main menu** screen, select the **Configuration**.
- From the **Configuration** screen, select:
 - **Display contrast**
 - **Measurement unit**

or

– **Language**

8.3.1 Display contrast

1. From the **MAIN MENU** screen, select **CONFIG. > Display contrast**.
2. Activate the display contrast adjustment.
3. Scroll up or down to select the setting you wish to use.
4. Save the settings.
5. Return to the default setting.

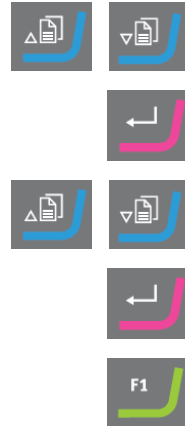

8.3.2 Changing the measurement unit

1. From the **MAIN MENU** screen, select **CONFIG. > Measurement unit**.
2. Activate the measurement unit adjustment.
3. Scroll up or down to select the setting you wish to use.
4. Save the settings.
5. Return to the default setting.

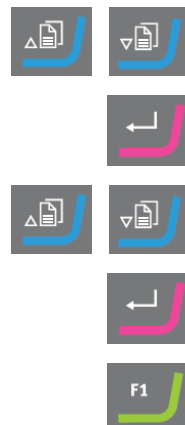



8.3.3 Language

Language

Select the language you wish to use. If needed, you can change the language at a later date.

1. From the **MAIN MENU** screen, select **CONFIG. > Language**.
2. Scroll up or down in the list to select the language of your choice.

9 Operating the device

- 
Note
 Before measuring, make sure that the sledge of the setup station is moved as far back as possible to allow unrestricted movement from the reference plane to the target plane.
- 
Note
 Before measuring samples on this setup station, make sure that the samples are at room temperature. If this is not the case, you can introduce an inaccuracy in the measurements for **Removal mode** and **Target mode** .
- 
Note
 The following procedure describes **Target mode** and **Removal mode**. If you are using **Removal mode**, use the edge of the sample chair instead of the reference edge.

Determining the distance between the reference edge and the target plane

1. Use the supplied Allen screwdriver to unlock the tilt locking screw in TargetGrip.
2. Insert TargetGrip in the TargetX dovetail connector and secure it with the locking knob.
3. Turn the motor lock-in wheel to move the tilt motor near TargetGrip.
4. Rotate the tilt motor shaft back and forth until it clicks into position in TargetGrip.
5. Make sure that TargetX is in target measuring mode . In this mode, **Target measuring** is highlighted on the display of the TargetX control unit.
6. Locate the target plane of the specimen. Roughly align the target plane with the vertical crosshair.
7. If needed, use the **Tilt to the left** and the **Tilt to the right** to perfectly align the target plane with the vertical crosshair.
8. Locate the reference edge.
9. Fine-position the reference edge at the point where the two crosshairs meet.
10. Set the zero reference point. The position shown on the TargetX console is set to 0.
11. Press the **Move quickly to the left** until the target plane is close to the vertical crosshair.

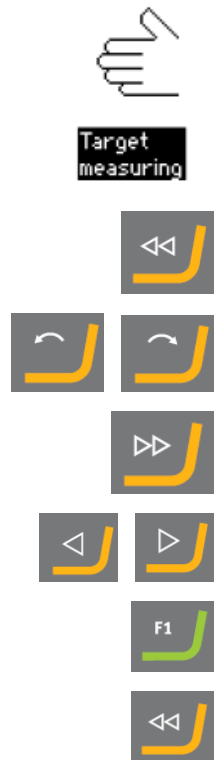

12. Fine-position the target plane at the vertical crosshair.
13. Note the target value shown on the TargetX control unit. Transfer this value manually to TargetMaster.
14. If you have multiple targets, use the controls on the control panel to move the specimen to the other targets and note the positions of these targets.
15. Turn the motor lock-in wheel to move the tilt motor away from TargetGrip.
16. Lock the tilt screw in TargetGrip.
17. Unlock the dovetail connector with the locking knob.
18. Remove TargetGrip from the x-ray chamber.

**Note**

You can always return to the reference edge during the measurements by pressing **F2** on the TargetX control panel.

10 Maintenance and service - TargetX

Proper maintenance is required to achieve the maximum up-time and operating lifetime of the machine. Maintenance is important in ensuring continued safe operation of your machine.

The maintenance procedures described in this section must be carried out by skilled or trained personnel.

Safety Related Parts of the Control System (SRP/CS)

For specific safety related parts, see the section "Safety Related Parts of the Control System (SRP/CS)" in the section "Technical data" in this manual.

Technical questions and spare parts

If you have technical questions or when you order spare parts, state serial number and voltage/frequency. The serial number and the voltage are stated on the type plate of the machine.

You can also find this information in the Duramin software by selecting **Tester > Info**.

10.1 General cleaning

To ensure a longer lifetime for your machine, Struers strongly recommends regular cleaning.

**Note**

Do not use a dry cloth as the surfaces are not scratch resistant.



Note

Do not use acetone, benzol or similar solvents.

If the machine is not to be used for a longer period of time

- Clean the machine and all accessories thoroughly.

10.2 Daily

- Clean all accessible surfaces with a soft, damp cloth.

10.3 Weekly

- Clean all accessible surfaces with a soft damp cloth and common household detergents.
- For heavy duty cleaning, use a heavy duty cleaning agent such as Solopol Classic.

10.4 Spare parts

Technical questions and spare parts

If you have technical questions or when you order spare parts, state serial number and voltage/frequency. The serial number and the voltage are stated on the type plate of the machine.

For further information, or to check the availability of spare parts, contact Struers Service. Contact information is available on Struers.com.

10.5 Service and repair

Struers recommends that a regular service check be carried out yearly or after every 1500 hours of use.

When the machine is started up, the display shows information about total operation time and the machines service information.

After 1500 hours of operation time, the display will show a message reminding the user that a service check should be scheduled.



Note

Service must only be performed by a Struers engineer or a qualified technician (electromechanical, electronic, mechanical, pneumatic, etc.).
Contact Struers Service.

Service check

Struers offers a range of comprehensive maintenance plans to suit the requirements of our customers. This range of services is called ServiceGuard.

The maintenance plans include equipment inspection, replacement of wear parts, adjustments/calibration for optimal operation, and a final functional test.

10.6 Disposal



Equipment marked with a WEEE symbol contains electrical and electronic components and must not be disposed of as general waste.

Contact your local authorities for information on the correct method of disposal in accordance with national legislation.



For disposal of consumables and recirculation fluid, follow local regulations.

11 Technical data

11.1 Technical data - TargetX

Subject	Specifications	
Safety standards	See the Declaration of Conformity	
Software and electronics	Controls	Touch pad
	Memory	FLASH-ROM/RAM/NV-RAM
Operating environment	Surrounding temperature	20 °C (68 °F) ± 2 °C (4 °F)
	Humidity	35-50 % RH non-condensing
Storage and transport conditions	Surrounding temperature	-20 – 60°C (-4 – 140°F)
	Humidity	35 - 50 % RH non-condensing
Power supply	Voltage/frequency	200-240 V/50/60 Hz
	Power inlet	1-phase (N+L1+PE) or 2-phase (L1+L2+PE) The electrical installation must comply with "Installation Category II".
	Power, nominal load	50 W
	Power, idle	10 W
	Current, nominal load	0.25 A
Current, maximum load	1 A	

Subject	Specifications	
Residual Current Circuit Breaker (RCCB)	Type B, 30 mA is required. <div style="border: 1px solid blue; padding: 5px; margin-top: 10px;">  Note Always follow local regulations. </div>	
Dimensions and weight	Width	705 mm (27.7")
	Depth	385 mm (15.1")
	Height	285 mm (11.2")
	Weight	13 kg (28.6 lbs)

11.2 Diagrams

If you wish to view specific information in detail, see the online version of this manual.

11.2.1 Diagrams - TargetX

Title	No.
TargetX, Block diagram	15753051 A
TargetX, Circuit diagram	15753121 A

17753051 A

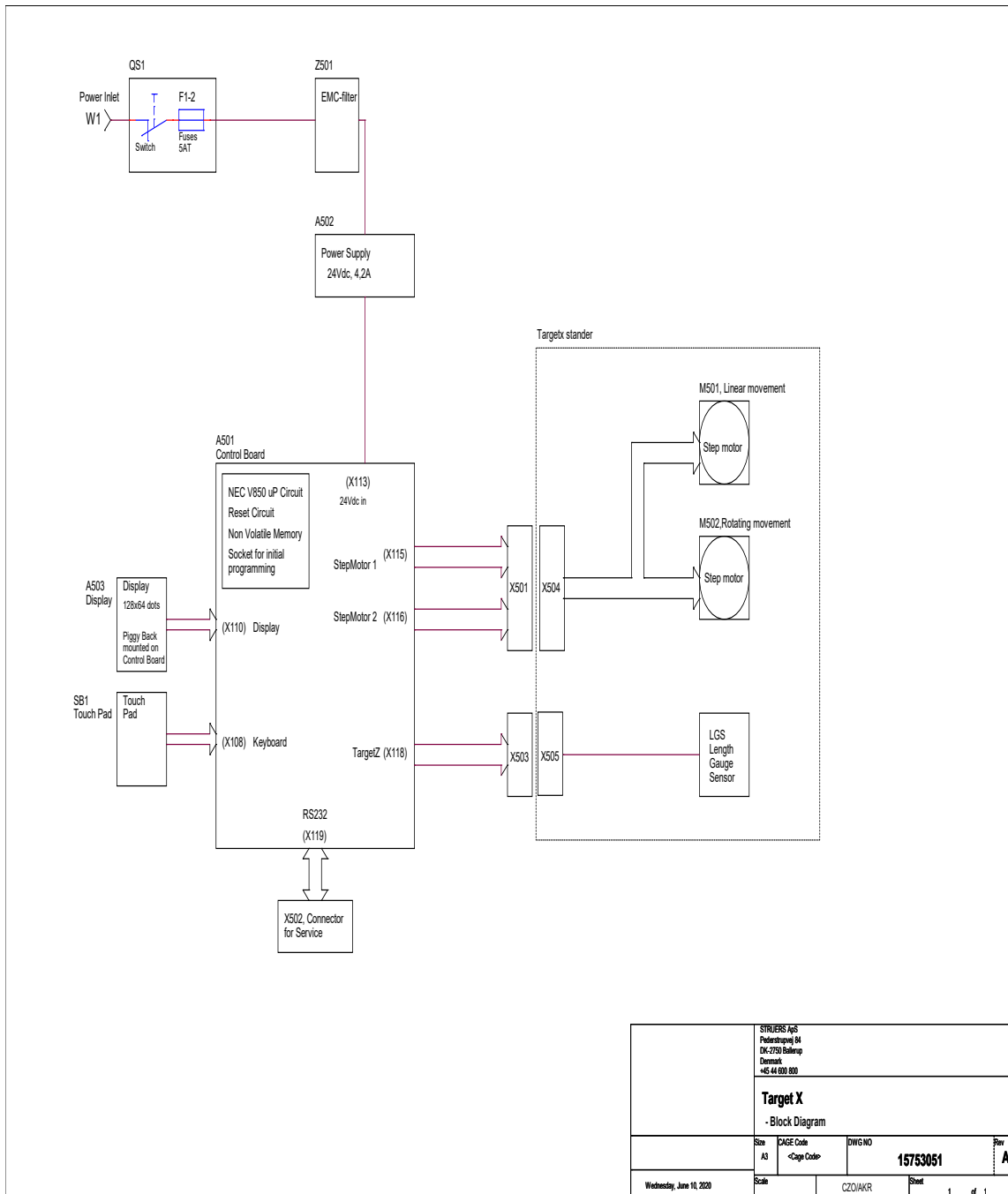

STRUEBS ApS Pedersbølvej 84 DK-2750 Ballerup Denmark +45 44 600 800			
Target X - Block Diagram			
Size A3	AGE Code <Age Code>	DWG NO 15753051	Rev A
Wednesday, June 10, 2020		Scale CZOIAKR	Sheet 1 of 1

15753121 A

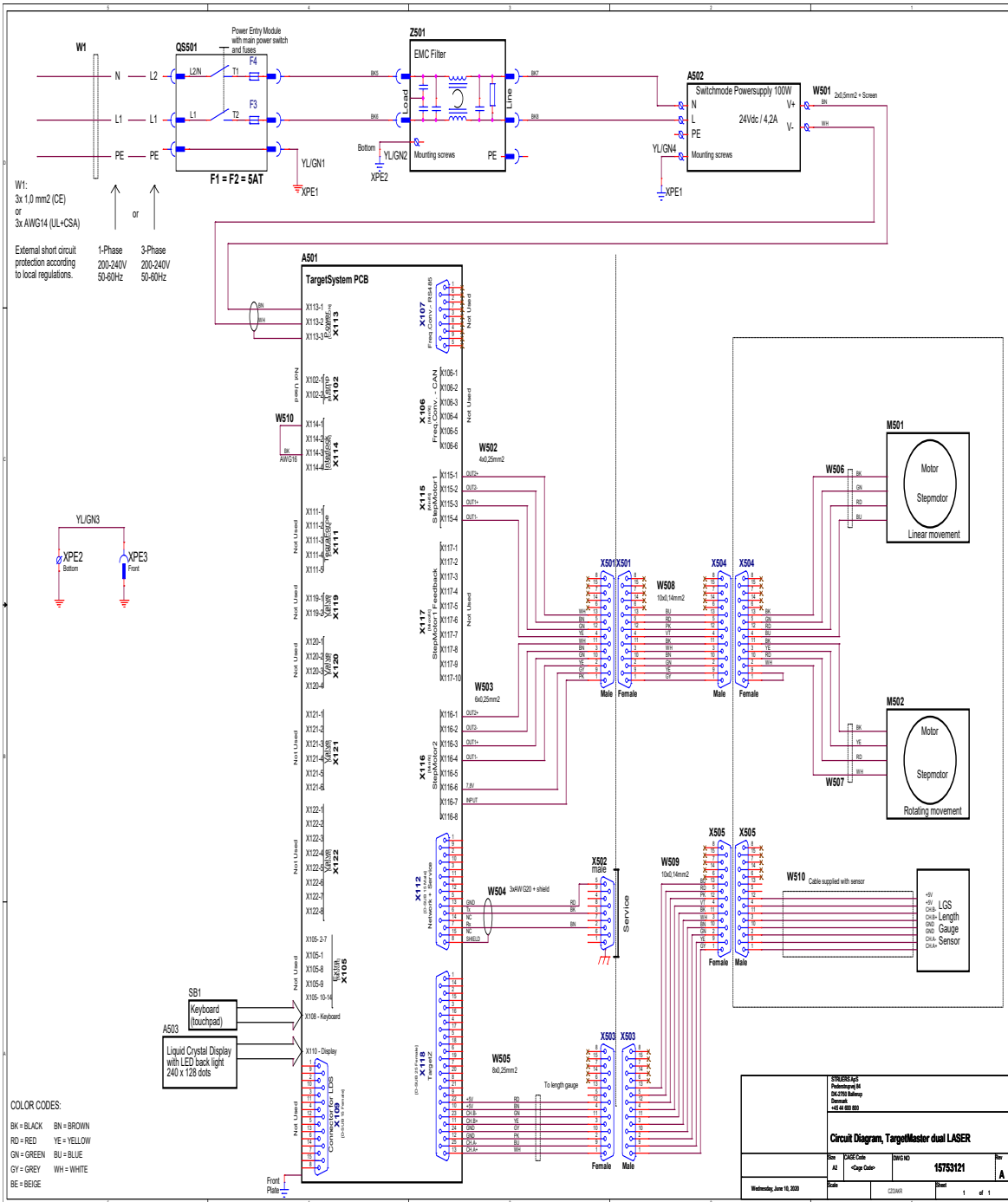

11.3 Legal and regulatory information

FCC notice

This equipment has been tested and found to comply with the limits for a Class B digital device, pursuant to part 15 of the FCC Rules. These limits are designed to provide reasonable protection against harmful interference in a residential installation. This equipment generates, uses and can radiate radio frequency energy and, if not installed and used in accordance with the instructions, may cause harmful interference to radio communications. However, there is no guarantee that interference will not occur in a particular installation. If this equipment does cause harmful interference to radio or television reception, which can be determined by turning the equipment off and on, the user is encouraged to try to correct the interference by one or more of the following measures:

- Reorient or relocate the receiving antenna.
- Increase the separation between the equipment and receiver.
- Connect the equipment into an outlet on a circuit different from that to which the receiver is connected.

12 Manufacturer

Struers ApS
Pederstrupvej 84
DK-2750 Ballerup, Denmark
Telephone: +45 44 600 800
Fax: +45 44 600 801
www.struers.com

Responsibility of the manufacturer

The following restrictions should be observed, as violation of the restrictions may cause cancellation of Struers legal obligations.

The manufacturer assumes no responsibility for errors in the text and/or illustrations in this manual. The information in this manual is subject to change without notice. The manual may mention accessories or parts not included in the supplied version of the equipment.

The manufacturer is to be considered responsible for effects on safety, reliability, and performance of the equipment only if the equipment is used, serviced, and maintained in accordance with the instructions for use.

Struers ApS
Pederstrupvej 84
DK-2750 Ballerup, Denmark

Declaration of Conformity

EU / UE / EL / EC / EE / ES / EÜ / AB

Manufacturer / Производител / Výrobce / Producent / Hersteller / Κατασκευαστής / Fabricante / Tootja / Valmistaja / Fabricant / Proizvođač / Gyártó / Fabbicante / Gamintojas / Ražotājs / Fabrikant / Producent / Fabricante / Producătorul / Výrobca / Proizvajalec / Tillverkare / 販売元 / 製作者 / Produsent / Изготовитель / Imalatçı / 製造商

Декларация за съответствие Prohlášení o shodě Overensstemmelseserklæring Konformitátserklärung Δήλωση συμμόρφωσης Declaración de conformidad Vastavusdeklaratsioon	Vaatumusten mukaisuusvakuutus Déclaration de conformité Izjava o skladnosti Megfelelőségi nyilatkozat Dichiarazione di conformità Atitikties deklaracija Atbilstības deklarācija	Verklaring van overeenstemming Deklaracja zgodności Declaração de conformidade Declarație de conformitate Vyhlásenie o zhode Izjava o skladnosti Intyg om överensstämmelse	適合宣言書 적합성 선언서 Samsvarserklæring Заявление о соответствии Uygunluk Beyanı 符合性声明
--	--	--	---

Name / Име / Název / Navn / Name / Όνομα / Nombre / Nimetus / Nimi / Nom / Naziv / Név / Nome / Pavadinimas / Nosaukums / Naam / Nazwa / Nome / Denumirea / Názov / Ime / Namn / 名前 / 제품명 / Наименование / Adı / 名称	TargetX
Model / Модел / Model / Model / Modell / Μοντέλο / Modelo / Mudel / Malli / Modèle / Model / Modell / Modello / Modelis / Modelis / Model / Model / Modelo / Modelul / Model / Model / Modell / モデル / 모델 / Modell / Модель / Model / 型号	TargetX
Function / Функция / Functie / Funktion / Funktion / Λειτουργία / Función / Functio / Toiminto / Fönction / Funkcija / Funkció / Funzione / Funkcija / Funkcija / Functie / Funkcja / Função / Funcția / Funkcia / Funkcija / Funktion / 機能 / 기능 / Funksjon / Назначение / Fonksiyon / 功能	For hidden targets. The machine includes a setup station and a console. The setup station is for placing the user's x-ray chamber (not included) and it is operated from the external console which allows for real-time alignment and measuring.
Type / Тип / Typ / Type / Typ / Τύπος / Tipo / Tüüp / Tyyppi / Type / Tip / Típus / Tipo / Tipas / Tips / Type / Typ / Tipo / Tipul / Typ / Tip / Typ / 種類 / 유형 / Type / Tvp / Tür / 类型	TargetX 05756923
Serial no. / Серийн номер / Výrobní číslo / Seriennummer / Seriennummer / Σειριακός αριθμός / N.º de serie / Seerianumber / Sarjanno / No de série / Serijski broj / Sorozatszám / N. seriale / Serijos Nr. / Sérijs Nr. / Serienr. / Numer serijny / N.º de série / Nr. serie / Výrobní č. / Serijska št. / Seriennummer / シリアル番号 / 일련번호 / Serienr. / Серийный номер / Seri no. / 序列号	

CE
Module H, according to global approach

en We declare that the product mentioned is in conformity with the following directives and standards:	es Declaramos que el producto mencionado cumple con las siguientes directivas y normativas:	hu Kijelentjük, hogy jelen termék megfelel a következő irányelveknek és szabványoknak:	ro Declarăm că produsul menționat este în conformitate cu următoarele directive și standarde:	ko 해당 선언서 상의 제품은 다음 지침 및 기준에 적합함을 선언합니다.
bg Декларираме, че посоченият продукт е в съответствие със следните директиви и стандарти:	et Kinnitame, et nimetatud toode vastab järgmistele direktiividele ja standarditele:	it Dichiariamo che il prodotto citato è conforme ai seguenti standard e direttive:	sk Vyhlasujeme, že uvedený výrobok je v súlade s týmito smernicami a normami:	no Vi erklærer at produktene som er nevnt er i samsvar med følgende direktiver og standarder:
cs Tímto prohlašujeme, že uvedený výrobek je v souladu s následujícími směrniciemi a normami:	fi Vakuutamme, että mainittu tuote on seuraavien direktiivien ja standardien mukainen:	lt Pareiškiamo, kad nurodytas gaminy's atitinka šias direktyvas ir standartus:	sl Potrjujemo, da je omenjeni izdelek v skladu z naslednjimi direktivami in standardi:	ru Настоящим заявляем, что указанная продукция отвечает требованиям перечисленных далее директив и стандартов:
da Vi erklærer herved, at det nævnte produkt er i overensstemmelse med følgende direktiver og standarder:	fr Nous déclarons que le produit mentionné est conforme aux directives et normes suivantes :	lv Mēs apstiprinām, ka minētais produkts atbilst šādām direktīvām un standartiem:	sv Vi intyggar att den angivna produkten överensstämmer med följande direktiv och standarder:	tr Belirtilen ürünün aşağıdaki direktiflere ve standartlara uygun olduğunu beyan ederiz:
de Wir erklären, dass das genannte Produkt den folgenden Richtlinien und Normen entspricht:	hr Izjavljujemo da je spomenuti proizvod sukladan sljedećim direktivama i standardima:	pt Declaramos que o produto mencionado está em conformidade com as seguintes normas e diretivas:	ja 弊社はこの指定製品が以下の指令および基準に適合することを宣言します。	zh 我们特此声明上述产品符合以下指令和标准:
el Δηλώνουμε ότι το εν λόγω προϊόν είναι σύμφωνα με τις ακόλουθες οδηγίες και πρότυπα:				

2006/42/EC	EN ISO 12100:2010, EN 60204-1:2006, EN 60204-1-A1:2009, EN 60204-1/Corr.:2010
2011/65/EU	EN 50581:2012
2014/30/EU	EN 61000-6-1:2007, EN 61000-6-3:2007, EN 61000-6-3-A1:2011, EN 61000-6-3-A1-AC:2012, EN 61000-6-1:2007, EN 61000-6-3:2007, EN 61000-6-3-A1:2011, EN 61000-6-3-A1-AC:2012
Additional standards	NFPA 79, FCC 47 CFR Part 15 Subpart B

Authorized to compile technical file/ Authorized signatory: Christian Skjold Heyde VP Operations Date: [Release date]

