

# Hardness Testing and Specimen Preparation

### 1. Introduction

Hardness testing is a useful tool for the evaluation of materials, quality control of manufacturing processes and in research and development work. It gives an indication of a material's properties, such as strength, ductility and wear resistance. In this application note we will consider the indentation hardness which is defined as: a measure of a material's resistance to plastic deformation, when a hard indenter penetrates into a softer material. The result obtained during testing will depend on the test used, i.e. the load and its duration, the type of indenter (geometry/material) and application of testing method. The hardness test used depends on the type of material, size of the part and its condition. Therefore, the method used should always be indicated together with the obtained result. There are different standards available which, if followed correctly, can secure a reliable result. Deviations from standard values, for example duration of test, should be noted in the hardness report. During hardness testing it is important to keep the parameters influencing the test under control in order to obtain accuracy and repeatability.

For metals, indentation hardness tests are employed. The most common tests in this category are Rockwell, Vickers, Brinell and Knoop. For Rockwell, the depth of penetration is used as a measure of the hardness while for Vickers, Brinell and Knoop, it is an optical measure of the size of the indent that is used. There are different standards available for all types of tests, in which the procedure/requirements for the actual hardness test are explained.

The hardness measurements can provide information about the material as a general quality control of material after processing or after heat treatments. Hardness tests are used in order to test hardenability of steel by Jominy testing, the hardened depth of surface hardened steel and controlling the performance of welds. Also there is a relationship between the hardness and yield stress/ultimate tensile stress, and the hardness test can give a qualified estimate of the mechanical properties [1, 2]. Another possible application is for ceramics/cermets/sintered carbides etc. where the fracture toughness ( $K_{IC}$ ) can be determined by using Vickers hardness testing together with a relationship based on Palmqvist's formula [3].

Other categories of hardness tests are:

- A dynamic test of metals is the Scleroscope hardness test, where the height of rebound of a hammer is used as a measure of the hardness.
- For minerals, a scratch test in which a harder mineral scratches into a softer one.

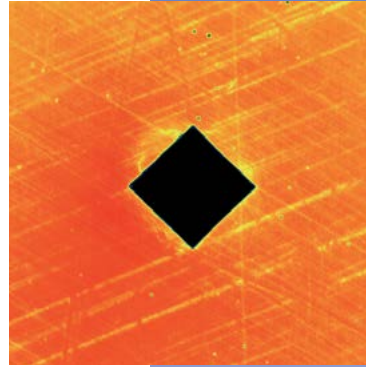

Automatic Tester Duramin-40



- For instrumented indentation testing (IIT) both hardness and elastic modulus can be determined accurately. During loading and unloading, the load-displacement curve is recorded for determination of the modulus.
- Different indentation tests are also used for testing hardness in plastics, like Shore (Durometer), Rockwell, the Ball indentation hardness test and Barcol.

This Application Note will focus on hardness testing of metals, the mechanical preparation of the specimens and the different parameters influencing the indentation hardness testing result.

## 2. Preparation difficulties

### Problem: 1

It can be difficult to obtain plane-parallel surfaces during preparation, see Figure 1. For instance, for Vickers (see page 5), the measured diagonals should not deviate more than 5% from each other. Also the indenter should be perpendicular to the test surface and not deviate from this with more than 2° in order to give a reliable result.

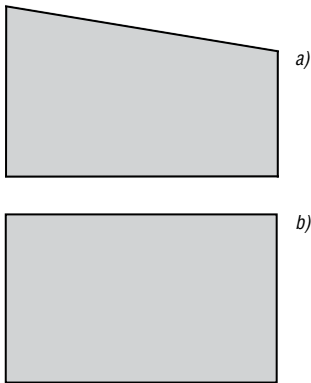

Figure 1: Sketch of a) an unplane specimen, b) a plane-parallel specimen

### Solution: 1

The best is to use a fixture to hold the specimen so that the indenter penetrates the surface perpendicularly, see Figure 2. If no fixture is available the mechanical preparation of the specimens need to result in plane-parallel end surfaces, see Figure 1b. It is possible to use the specimen holder A with a plane end surface, see Figure 3, in which the specimens are fastened by the use of double-adhesive tape, in order to achieve as plane-parallel specimens as possible. When using Figure 3A it is important that the specimens are cut to approximately the same height. When using Figure 3B, see Figure 3, the final plane-parallelism of the specimen surfaces depends highly on how the operator has clamped the specimens in the holder.

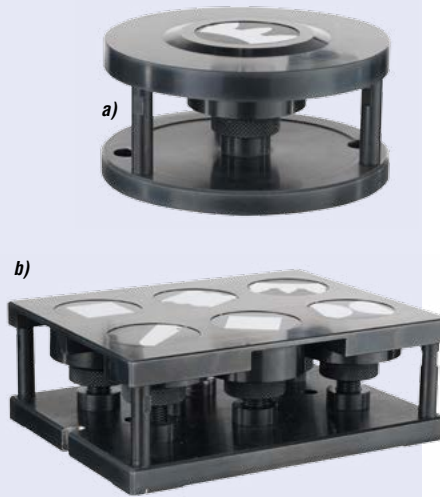

Figure 2: Fixtures to hold specimens during hardness testing, a) 1 x 40 mm diam., b) 6 x 30 mm diam.

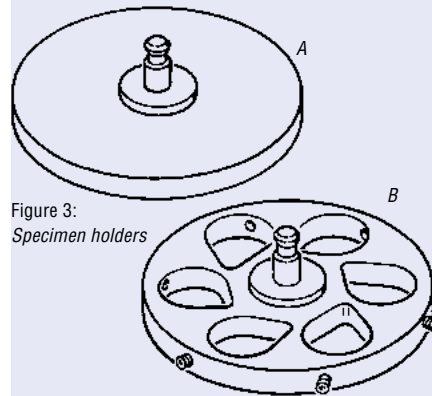

Figure 3: Specimen holders

### Problem: 2

If the surface finish of a specimen is too rough, it might be problematic to evaluate the corners of an indent, especially if automatic equipment is used. A clean reflective surface is needed. Also the surface preparation should have a minimum influence on the properties of the material to be tested. The surface preparation needed is dependent on the type of test and the applied load. Micro hardness (loads lower than 1 kgf) requires a more polished surface. Rockwell tests are not as sensitive to surface preparation as the depth of penetration is measured and, not an optical measure of the geometry of the indent is performed, therefore no preparation or a ground surface can be sufficient.

If the surface is too rough, scratches from the preparation may cause a misreading of the indent size, when using automatic hardness testing. Note that softer materials are more sensitive to

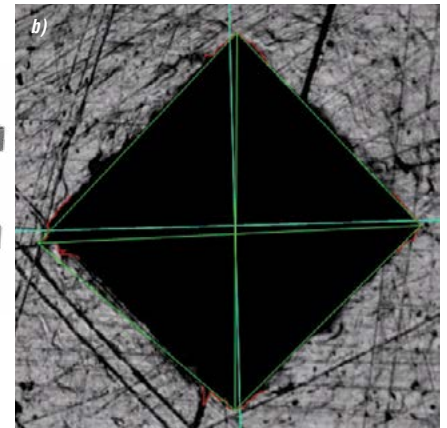
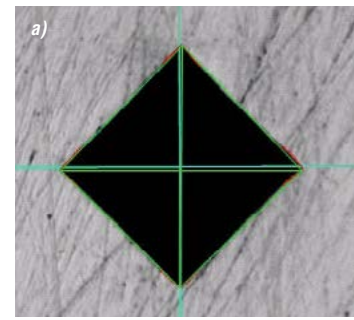

Figure 4: Vickers indents on the same rough surface preparation (9µm) for a) Hardened steel 715 HV 10 and b) 0.5% carbon steel 180 HV 10. Here 17% of the indentations of the carbon steel were discarded due to the rough surface, while no problems were encountered for the hardened steel.

preparation artefacts since the same size of abrasives will introduce larger deformations/scratches in the surface than in harder materials, see Figure 4.

### Solution: 2

A polished surface should be used. Figure 5 shows the surface after final

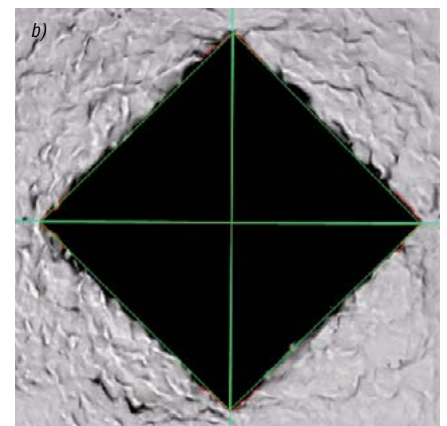
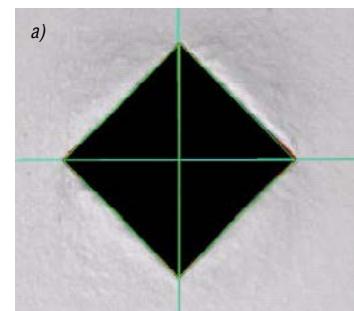

Figure 5: Vickers indents on a smooth surface, MD-Plus/DiaPro Plus, 3µm.

a) Hardened tool steel, 715 HV 10.  
b) 0.5% carbon steel, 180 HV 10.

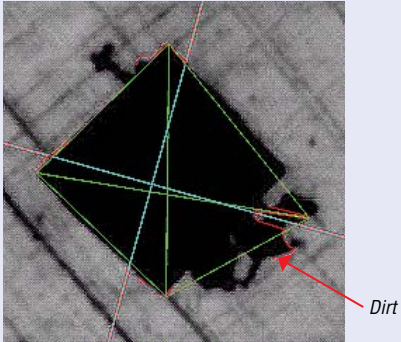

Figure 6: Dirt disturbing the automatic optical reading. Material is hardened tool steel. Vickers hardness test. Load 0.5 kgf<sup>1</sup>. Final preparation on surface MD-Largo with diamond suspension DiaPro Allegro/Largo 9 (9 µm).

polishing with the MD-Plus cloth and the diamond suspension DiaPro Plus 3 (3µm).

**Problem: 3**

If the specimen is not properly cleaned after mechanical preparation and an optical reading of the hardness test takes place, an automatic reading might result in a misinterpretation of the corners of the indent, see Figure 6.

**Solution: 3**

Always ensure that the specimens are cleaned properly, otherwise e.g. dirt or fibres from the polishing cloth might complicate the reading.

**Problem: 4**

For a heavily etched sample, it might be difficult to evaluate the corners of an indent, which may lead to a less accurate hardness value.

**Solution: 4**

Etching should, as far as possible, be avoided since it results in a less reflective surface. If etching is necessary, a light etch is preferable so that it will be possible to discriminate the corners of the indent. Sometimes, it can be necessary to etch, for example when evaluating a weld, see Figure 20.

<sup>1</sup> In this Application Note, the test forces are given in kgf (kilogram force), a unit introduced before the SI-system came in use. (1kgf=9.81N)

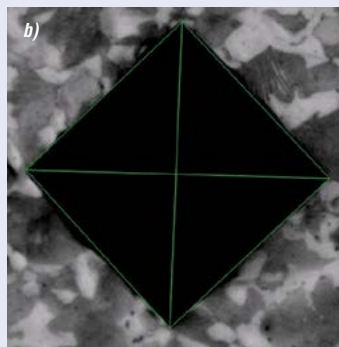
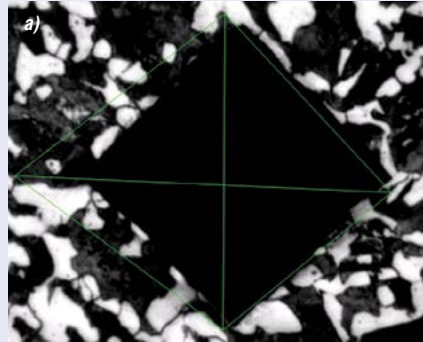

Figure 7: Vickers indents, load 1 kgf. Material is 0.5% carbon steel. Final preparation step is MD-Plus with diamond suspension DiaPro Plus 3 (3µm). Etched with 3% Nital a) heavily etching b) light etching.



Simple fixture in Duramin-40

**3. Description of principles**

For hardness indentation tests, where the size of the indent is determined optically, as for Vickers, Brinell and Knoop, the hardness is defined as the applied load divided with the contact area (for Knoop it is the projected area). The tests can be performed manually by using tables where the mean value of measured diagonals/diameters is converted into a hardness value or the value may be calculated based on a formula, or by an automatic hardness testing machine where the hardness is determined automatically.

Depending on the size of the applied load, the indentation hardness test can be divided into macro (also called general or universal) and micro hardness testing. For macro hardness testing, the test loads are 1 kgf (9.81 N) or larger, while micro hardness testing covers the load range from 1 gf to 1 kgf.

The required surface condition depends on the type of test and load used. For macro hardness usually a milled or ground surface is sufficient, sometimes no preparation at all is required.

Table 1: Surface requirements for the different hardness indentation tests.

Test	Surface Preparation
<b>Rockwell HR</b>	<b>Macro hardness test:</b> - no surface preparation or - ground
<b>Brinell HBW</b>	<b>Macro hardness test:</b> - milled, - ground or - polished
<b>Vickers HV</b>	<b>Macro hardness test:</b> - ground <b>Micro hardness test:</b> - polished - electropolished
<b>Knoop HK</b>	<b>Micro hardness test:</b> - highly polished



For micro hardness testing a polished surface is needed, for very small loads even oxide polishing or electrolytic polishing might be needed.

The surface roughness has little influence on the size of the indent, as long as the indent is large in comparison to the asperities of the surface [1]. It is important that the surface preparation does not alter the material properties, i.e. the surface should show a minimum of deformation after preparation.

Conversions between hardness scales should be handled with care. It is best to avoid conversions if possible and perform the hardness tests by the method

required. The same goes for conversions from hardness measurements to material strength, if they are not well founded by experimental data.

**Rockwell (HR)**

Rockwell is a fast method, developed to be used for production control and has a direct readout. The Rockwell hardness (HR) is calculated by measuring the depth of an indent, after an indenter has been forced into the specimen material at a given load. The indenter material is a conical diamond, or sintered carbide ball, depending on the scale being used. A minor preload is applied before the main load is put on and thereafter unloaded. The readout of the hardness value is performed while the minor pre-load is still applied, see Figure 8.

There are two types of Rockwell tests: regular Rockwell where the minor load is 10 kgf, the major load is 60, 100 or 150 kgf; and Superficial Rockwell, used for thinner specimens where the minor load is 3 kgf and major loads are 15, 30 or 45 kgf. Generally, the tested material should not be mounted in resin, because the Rockwell test uses the motion of the indenter to measure the hardness and not the indentation area. The influence hereof however depends on the machine used.

**Brinell (HBW)**

Brinell indentation gives a relatively large impression with a tungsten carbide ball, denotation HBW (W is the chemical symbol for tungsten). The size of the indent is read optically in order to determine the hardness. Typical applications are forgings and castings where the structural elements are large and inhomogeneous or structures too coarse for other methods (Rockwell/Vickers) to give a representative result. Load Range: 1-3000 kgf Indenter Types: 1 / 2.5 / 5 / 10 mm diameter balls.

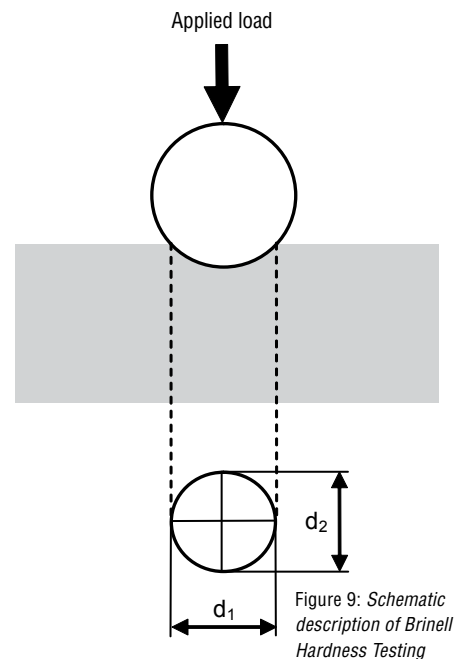

Figure 9: Schematic description of Brinell Hardness Testing



Rockwell Tester, Duramin-160



Universal Tester, Duramin-40

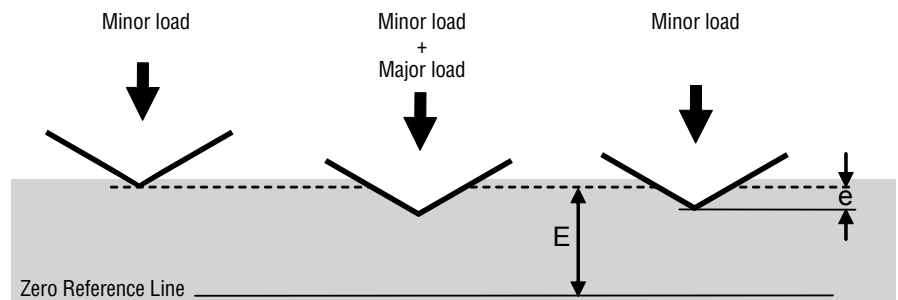
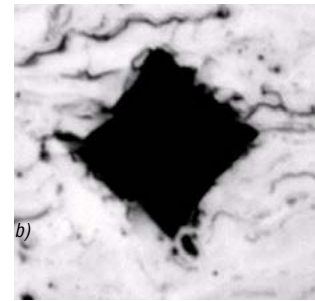
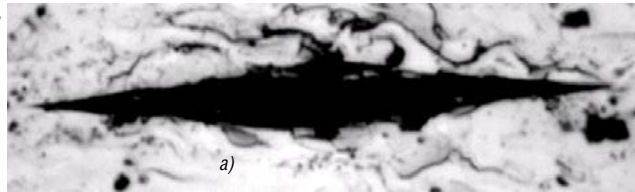

Figure 8: Schematic description of Rockwell Hardness Testing. Rockwell Formula: Hardness Rockwell HR = E - e. "E" is a constant of 100 (diamond) or 130 (ball) units. "e" is the penetration depth in units of 0.002 mm

Figure 13: Comparison of indent size between a) Knoop and b) Vickers indent in plasma spray coating. Load 0.5 kgf. The final polishing step was performed with the Nap cloth and diamond suspension DiaPro Nap B 1 (1µm).



**Vickers (HV)**

The Vickers Hardness (HV) is calculated by measuring the diagonal lengths of an indent left by introducing a diamond pyramid indenter with a given load into the sample material, see Figure 10. The size of the indent is read optically in order to determine the hardness. The hardness value can be obtained from a table or formula after determining the mean value of the two measured diagonals or directly in an automatic hardness tester. The Vickers scale ranges from 10 gf to 100 kgf. For Vickers hardness testing, the obtained hardness value is relatively unaffected by the applied load. For spacing between Vickers indents, see Figure 23.

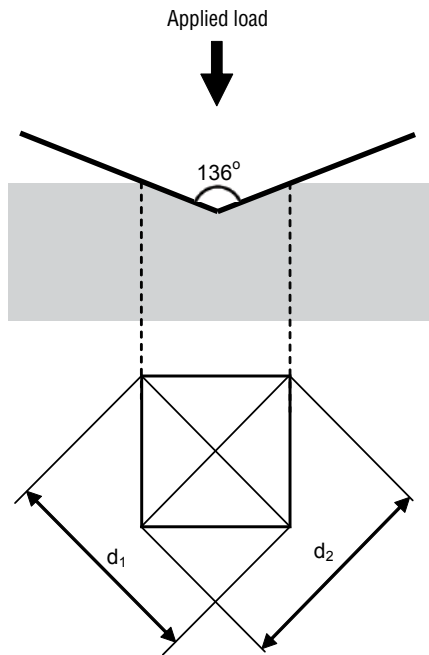

Figure 10: Schematic description of Vickers Hardness Testing.

**Knoop (HK)**

This method was developed as an alternative to the Vickers indenter, mainly to overcome cracking in brittle materials (such as ceramics), but also to facilitate testing of thin layers. The indenter is an asymmetrical pyramidal diamond, see Figure 11. The size of the indent is based on a measurement of only the long diagonal, which is read optically in order to determine the hardness. The load range for Knoop varies from 10 gf to 1 kgf. Knoop is more sensitive to surface preparation compared to Vickers since the longer diagonal results in a shallower indent. The spacing between indents is material dependent, see Figure 12. When using Knoop for very small loads, the hardness value increases with decreasing load.

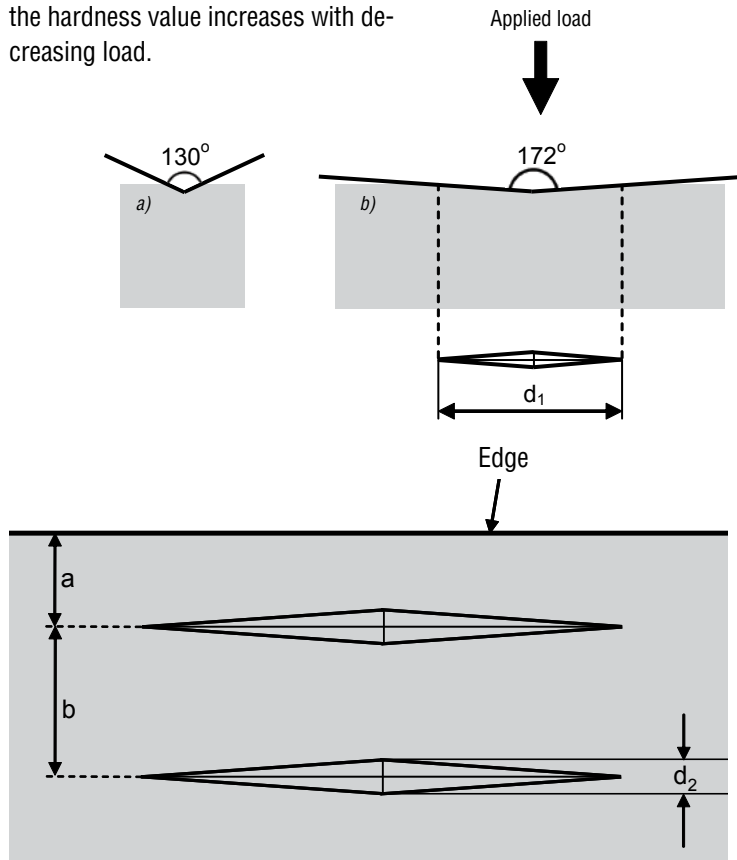

Figure 11: Schematic description of Knoop Hardness Test a) side view b) front view

Figure 12: The indentation spacing of Knoop is based on the short diagonal  $d_2$ . a and b are explained in the below table (ISO 4545).

	a	b
Steel, copper and copper alloys	$3 \cdot d_2$	$4 \cdot d_2$
Light metals, Pb, Sn and their alloys	$3.5 \cdot d_2$	$7 \cdot d_2$

Comparison of indent size between a Knoop and Vickers indent for the same load is found in Figure 13.

For Brinell, Vickers and Knoop it is important that the diagonal lengths are at least 20 µm or larger, otherwise measurement inaccuracy will be too high.

**Microhardness testing**

For micro hardness testing the test loads are, as mentioned before, less than 1 kgf and results in very small indentations. Micro hardness extends the hardness testing to materials too thin or too small for macro indentation tests, the load range being 1 gf –1000 gf, as specific



phases or constituents and regions or large hardness gradients are tested. Examples are very thin layers, small components, coatings, micro-welds, powder metal particles, individual structural elements or grains.

It is better not to etch before hardness testing because the surface will become less reflective resulting in an indent on which it is more difficult to see the corners. However, a light etch will help to discriminate between different phases/structure elements when hardness measurements are performed on individual constituents.

Also the lower the loads used during hardness testing, the higher the requirements to surface preparation that can be performed mechanically, chemically or electrochemically. It is important that no change of surface properties is induced to the specimen during preparation due to heating or cold working. Deformations introduced during cutting and grinding need to be removed by polishing down to 6, 3 or 1  $\mu\text{m}$  depending on the test load. For very small loads, less than 300 gf [4], the surface needs to be completely free of deformations, and the specimens require oxide polishing or even electrolytic polishing to obtain a completely damage-free surface. One should also take into account that soft or/and ductile materials (i.e. for HV less than 120-150) are more sensitive when it comes to introducing preparation artefacts.

It is important to have a plane test surface to get reliable results, placing the specimen in a fixture will ensure that the indenter is perpendicular to the test surface.

## 4. Preparation recommendations

### Cutting

Cutting should introduce as little deformation as possible to the specimen. Therefore it is important to select a proper combination of cut-off wheel and feed speed for the material in question, to prevent burning of the material and to ensure as short a preparation time as possible in the following steps.

### Mounting

Tests<sup>1</sup> show that there is no significant influence of resins, see Figure 14, for test loads up to at least 30 kgf (Vickers). (Tests were performed with two hot mounting resins DuroFast (epoxy with mineral filler) and MultiFast (phenolic mounting media with wood flour filler) and one cold mounting resin, ClaroCit (acrylic resin). If edge-retention is needed as for thin coatings or surface treated steels, a resin

with filler should be used. For hardened steel, DuroFast is appropriate. For softer materials/coatings (less than 400HV) LevoFast (melamine with mineral and glass filler) is suitable.

### Grinding and polishing

The grinding and polishing method depends on the material to be tested. For ferrous metals, a common method is presented in Table 2. It is suitable for most steel grades/heat treatments, for example case hardened steel. The final polishing is performed with 3  $\mu\text{m}$  diamond suspension. It is a fast method which gives a reflective surface suitable for hardness testing. For softer aluminium, the method in Table 3 is recommended. Figure 15 shows automatic evaluation of hardness of 99,95% aluminium after cutting as well as after different steps of mechanical preparation. For preparation of different materials, see e-Metalog ([www.struers.com](http://www.struers.com)). The data in Table 2 and Table 3 are valid for 6 mounted samples, 30 mm in diameter, clamped in a holder.

<sup>1</sup>Tests were performed with 0.5% carbon steel and hardened tool steel, the diameters of the mounted steel specimen were 25 and 32 mm in diameter respectively. All mounts were 40 mm in diameter. Each column in Figure 14 represents 3 series of 12 indents except for ClaroCit where only one test series was performed.

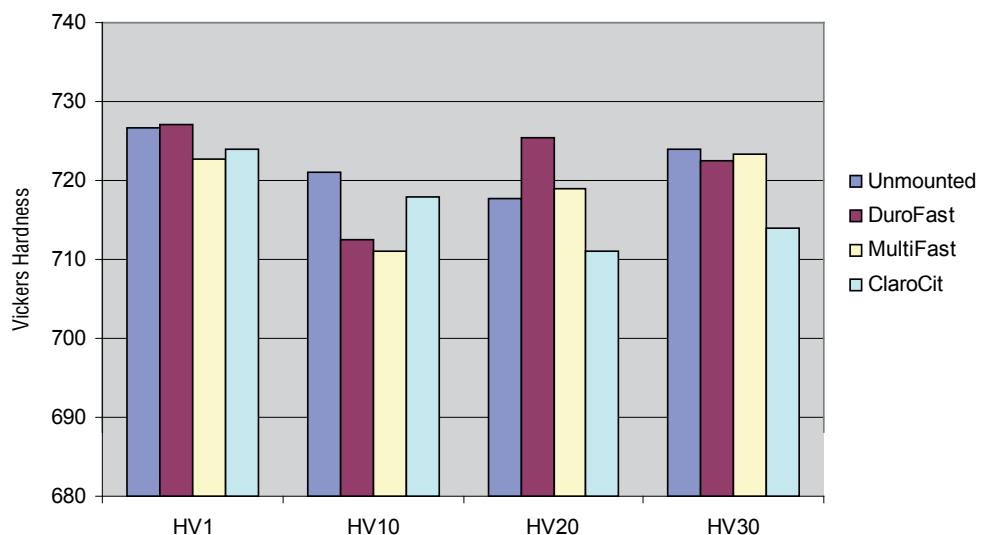

Figure 14: Results from tests investigating the influence of resins on hardness testing. Here, the specimens were placed directly on an anvil during the test. The material was hardened tool steel. Final polishing step was carried out on a MD-Plus cloth with diamond suspension DiaPro Plus 3 (3 $\mu\text{m}$ ).

Step	PG	FG 1	P 1
Surface	MD-Piano 220	MD-Allegro	MD-Plus
Abrasive type		DiaPro Allegro/Largo 9	DiaPro Plus 3
Lubricant type	Water		
Speed [rpm]	300	150	150
Force [N]	240	240	180
Holder direction	>>	>>	>>
Time [min]	1	3	3

Table 2:  
Preparation  
method for steel.  
Valid for six  
mounted speci-  
mens 30 mm  
in diameter.

Step	PG	FG 1	P 1	OP
Surface	SiC-Paper #320	MD-Largo	MD-Mol	MD-Chem
Abrasive type		DiaPro Allegro/Largo 9	DiaPro Mol R 3	OP-U NonDry 0.04 µm
Lubricant type	Water			
Speed [rpm]	300	150	150	150
Force [N]	120	180	150	90
Holder direction	>>	>>	>>	<<
Time [min]	1	4	3	2

Table 3: Preparation method for soft aluminium. Valid for 6 mounted specimens, 30 mm in diameter.

When using very fine polished surfaces i.e. oxide polishing, it should be noted that OP-U NonDry results in less relief than OP-S.

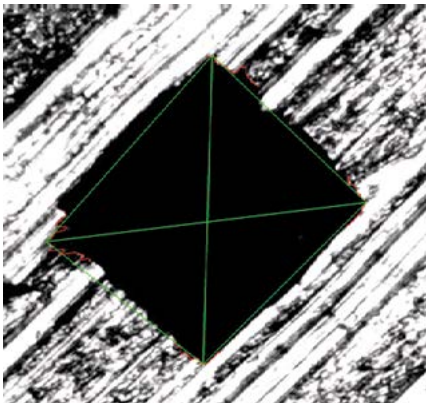

a)

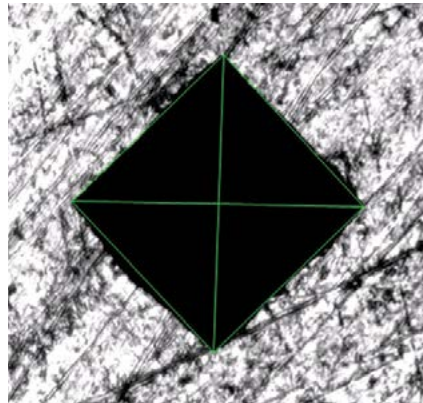

b)

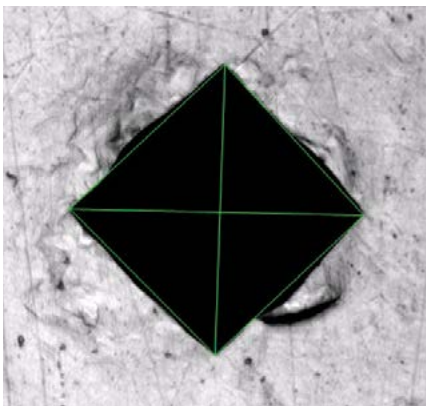

c)

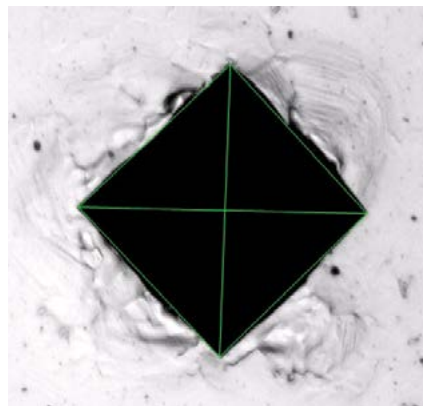

d)

Figure 15: Vickers hardness testing, HV1 of 99.95% aluminium a) directly after cutting b) after fine grinding with MD-Largo and diamond suspension DiaPro Allegro/Largo 9 (9 µm) c) after polishing with MD-Mol and DiaPro Mol 3 (3 µm) d) after oxide polishing with MD-Chem and OP-U NonDry (colloidal silica 0.04 µm)

## 5. Applications

### Case hardness depth

To increase wear resistance, steels are surface-hardened for applications in moving and rotating parts such as gears, nozzles, engine parts, etc.

A quantitative measure of the change in hardness can be obtained by a hardness transverse.

Case hardness depth (CHD) measurements are used in order to determine the thickness of the hardened surface layer of steel. The procedures are standardised and evaluation of the case depth depends on the method used during the surface hardening, for example if it is induction hardened, carburized or nitrided, etc. In most cases Vickers hardness tests are used in the micro hardness load range. (In certain cases Knoop can be used).

Edge-retention is needed when measuring thin coatings or heat treated surfaces. When performing a CHD, the size

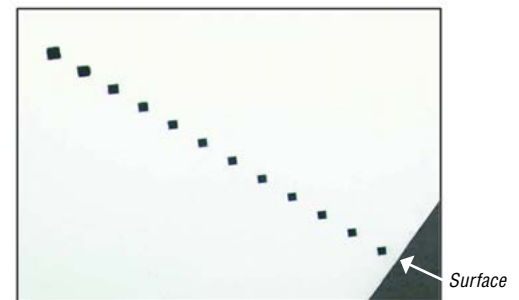

Figure 16: Case depth measurement. The increasing size of the indentations towards the centre of specimen indicates decreasing hardness of the material.

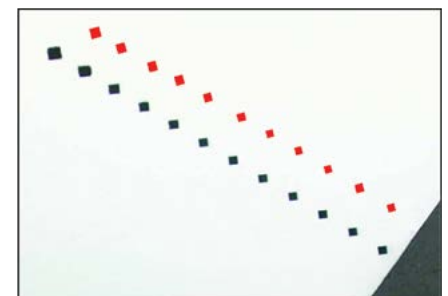
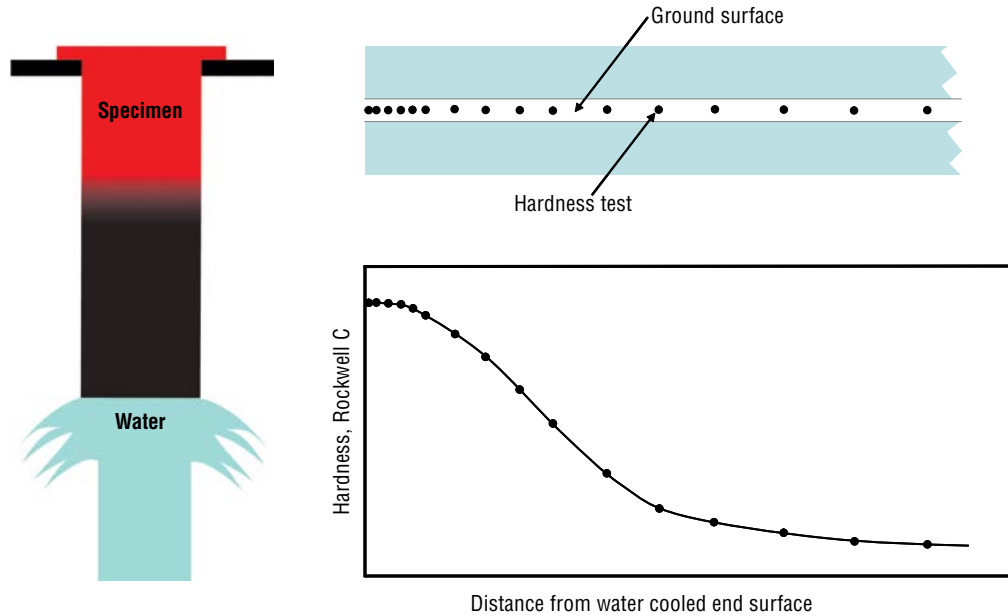

Figure 17: Indents forming a zig-zag pattern.

Figure 18: Schematic description of Jominy Test.  
 (For example Jominy Number: J15 = 35 HRC means that the hardness 35 HRC is measured at a distance of 15 mm from the water cooled end)



of the indents will increase as the hardness decreases, see Figure 16. In order to keep the minimum allowed distance between indents (for steel 3x diagonal), automatic indent spacing can be used. As the indent size increases, the distance between the indents will also increase.

Traditionally, a large number of indents needs to be performed in order to reach the hardness limit. However, it is possible with modern automatic hardness testers to stop automatically when the defined hardness number is reached, regardless of the number of test points which have been set.

There is a minimum indent spacing, since the indents should not influence each other. In order to increase the number of indents and the accuracy in test series, the indents can be displaced in relation to each other, forming a zig-zag pattern, see Figure 17.

### Jominy Testing

With the Jominy test, the hardenability of a steel is tested. A test bar with specific geometry is heated up to an austenitising temperature, thereafter the end is cooled down using a standardised water jet, see Figure 18. After cooling, one side of the bar is ground and the hardness is measured (HV 30 or HRC) at intervals from the quenched end, see Figure 19. Depending on the cooling rate (distance from the water cooled end) there will be differences in the measured hardness.

### Welding

Hardness testing of welds typically implies that a series of indents have to be performed across a relatively large specimen surface, closely related to the geometry of the specimen. An overview camera allows the entire specimen sur-

face to be seen and easily displays the positions where the indents should be performed. Welding standards prescribe the use of HV 5 or HV 10.

An example of location of hardness test indentations for the validation of a weld

are shown in Figure 20. Before the hardness test the test surface is polished down to 3 µm and thereafter slightly etched before testing.

For preparation of welds, see the Application Note on the subject.

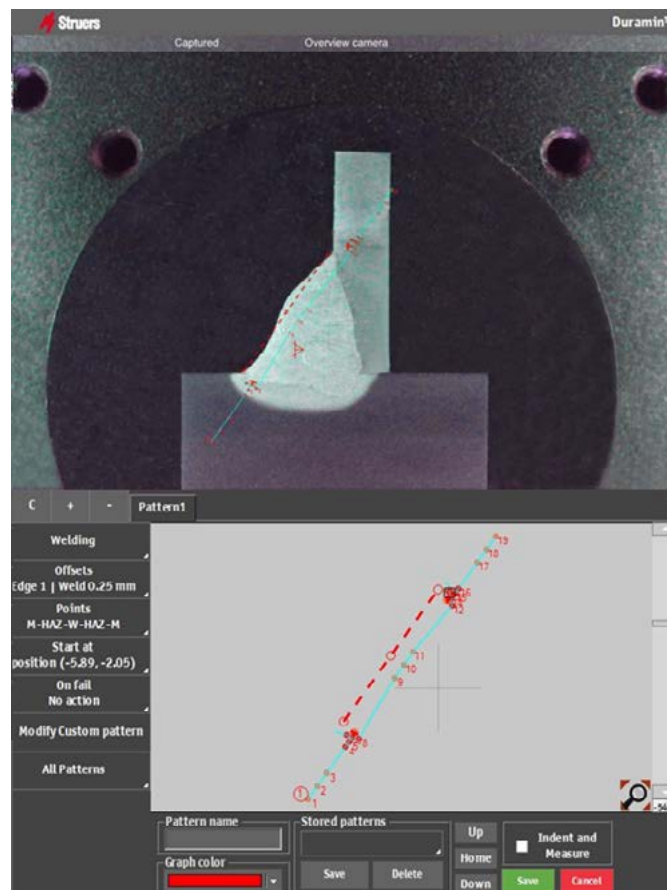

Figure 20: Placing of test points on weld with the help of an overview camera.



Applied Load	Indentation	Indenter	Others
Accuracy	Speed	Lateral movement	Anvil, Support table
Repeatability	Inertia	Shape deviations	Spindle
	Angle	Damage	Deflection of sample
	Time	Material	Levelling of machine
	Spacing		

Table 5: Instrument Factors

## 6. Controlling Parameters

Hardness tests are considered to be rather simple to perform when all parameters are controlled. For this reason it is advisable to have a basic knowledge of the subject. Below follows a brief overview of parameters influencing the hardness test.

The different parameters can be divided into five main factors influencing the hardness testing and they are related to instrument, measurement, material, operator and environment, see Figure 21. It is important to continuously seek to eliminate, minimize or at least take into account the influence of these factors, which will be mentioned/discussed in the following:

### Operator factors

The operator should have an understanding of the proper operation of the hardness testing equipment, surface requirements and fixture techniques in order to use the machine as effectively as possible and thus minimize the work needed during testing.

### Environment factors

The hardness test should be performed on a smooth clean reflective surface (valid for Vickers, Brinell and Knoop). It

is important to perform the tests under constant conditions like temperature and humidity. For indenters with optical reading, it is necessary to take into account that the illumination influences the interpretation of the indent size. Therefore, the hardness tester should preferably be placed in a dark environment to keep the illumination constant. Vibrations from the surroundings will affect the measurement and should be minimized. Smaller loads are more sensitive to vibrations. For this reason, it is advisable to place the hardness tester on a special foundation (e.g. granite table).

The surfaces should be free from any kind of contamination such as scale, dirt, oil and grease. A thin lubricating film will lower the coefficient of friction resulting in larger indents for a given load, that is to say one will experience slight decrease in hardness. Here, it is important to keep the same condition of surfaces for all measurements to get comparable results.

### Instrument factors

For the instrument factors, the load, the indentation and the indenter are considered. To obtain the necessary accuracy and repeatability of the applied load, a load cell technology is preferred

since it is more accurate than systems with mechanical weights, i.e. free from influences of friction and inertia within the system. To fulfil the requirement of accuracy of the applied load, it is also important to calibrate the system regularly. In the daily routine, this is mostly an indirect verification, using calibration blocks which are available for different hardness levels, making it possible to verify the calibration in the used hardness range. The parameters affecting the indentation can be found in Table 5. The angle of indentation should not deviate from the perpendicular line more than 2 degrees (maximum), otherwise errors are introduced. Also, there should be no lateral movement between indenter and specimen. If possible, the specimen should be clamped on a burr-free anvil.

Spacing between indents should be large enough for the indents not to influence each other. The plastic deformation around an indent will cause most materials to harden, therefore if the indents are too close, the material will appear to be harder. The principle for the development of the plastic zone (blue area) for a flat punch (yellow) is shown in Figure 22.

For this reason, the standards for the different tests give specifications for the spacing between indents and the spacing towards the edge, for Vickers hardness testing, the instruction given by ISO can be seen in Figure 23.

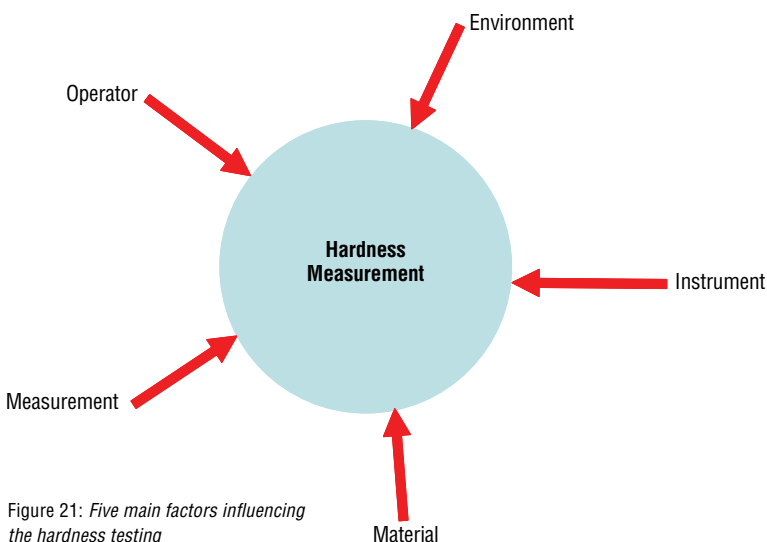

Figure 21: Five main factors influencing the hardness testing

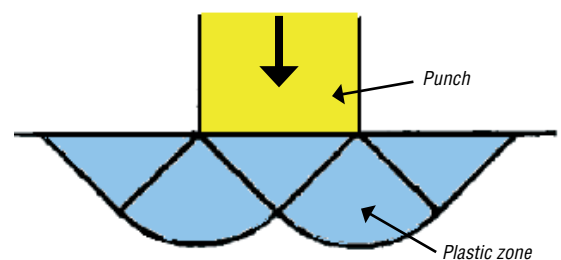
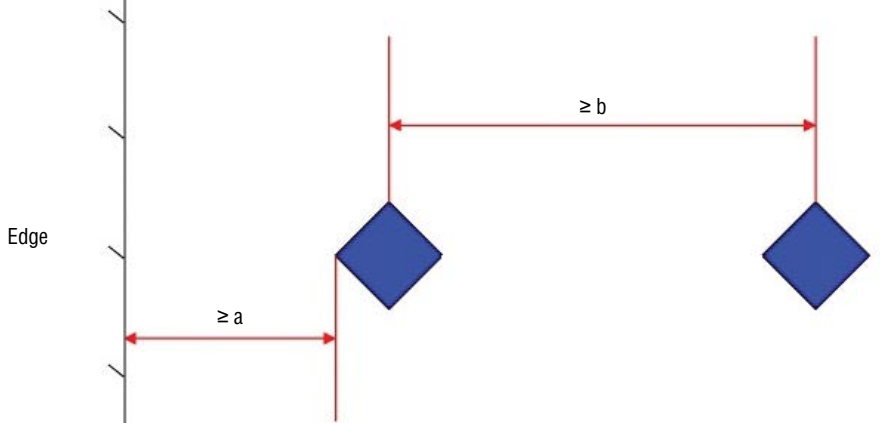

Figure 22: Slip-line field of plastic zone (blue area) development from indent of a rigid flat punch (yellow) according to Prandtl



	a	b
Steel, copper and copper alloys	2.5·d <sub>m</sub>	3·d <sub>m</sub>
Light metals, Pb, Sn and their alloys	3·d <sub>m</sub>	6·d <sub>m</sub>

Figure 23: Spacing between Vickers indents according to ISO 6507, a and b are explained in the table below, where d<sub>m</sub> is the mean diagonal of an indent.

### Material factors

The material factors are:

- Heterogeneity of microstructure
- Quality of specimen preparation
- Reflectivity/Transparency of specimen surface
- Type of material
- Material treatment
- Shape of material
- Mounting resin

An appropriate specimen thickness is needed; the indent should not penetrate through the entire specimen. It is important that there is no visible deformation present at the back of the test piece after the hardness test.

For this reason, the specimen thickness should be at least 10 times the indentation depth (Rockwell). For Vickers it has to be at least 1.5 times the diagonal length of the indentation.

Corrections need to be performed when measuring on spherical and cylindrical surfaces. The correction factor will depend on the surface being concave or convex. These correction factors can be found manually in tables or they are incorporated in newer automatic hardness testers. For round specimens, also special anvils should be used and correction factors for convex surfaces.

When choosing a suitable type of hardness test, it is important that the indent area covers all different structural elements present in the tested material in order to obtain an indentation that represents the whole structure of the material. For example, for a cast structure, hardness testing is preferably performed with Brinell, since this type of structure

Procedure used	Verification System	Others
Applied method (HV, HB, HR, HK)	Calibration of loading systems	Vibrations
Feasibility of method	Magnification of objective lenses	Dirt, dust, debris
Standard to be followed (ASTM, ISO, JIS)	Resolution of objective lenses	
	Inadequate image quality	
	Uniformity of illumination	

Table 6: Measurement Factors

is rather inhomogeneous and therefore a larger indent is needed to cover the different structural elements.

### Measurement factors

The measurement factors are found in Table 6. If a hardness tester is used for performing several different hardness tests, it is necessary to verify each test separately. Before verification takes place, it should be checked that the illumination does not affect the readings.

For hardness testers based on optical readings, as high loads as possible should be used to minimize errors. The diagonal/diameter length of the indentation should be larger than 20 μm. For Vickers, the difference in diagonal length for the same indent should be less than ±5%. For optimal results, when possible, the diagonal should be between 25-75% of the field of view of the lens. When determining large hardness gradients, for example for case hardening, this requirement can be difficult to fulfil.

It is important that the indenter is free from faults/surface defects in order to get reliable results. It can preferably be checked on a daily basis by visual inspection of an indentation in a refer-



Rockwell Tester, Duramin-160

ence block, to ensure there are no flaws, cracks etc. on the indenter surface (Vickers ISO 6507). As soon as a defect is present on the indenter, no reliable results can be obtained.

## 7. Which method do I use?

**Vickers** is the most versatile method, due to only one indenter and many loads (micro/macro hardness range). Can be used for all materials and many applications (case hardness depth measurements, Jominy testing, welds, ceramics and coatings), but requires a relatively good surface finish.

**Knoop** has fewer loads (micro hardness range) compared to Vickers and is in particular suitable for ceramics and thin coatings and requires a good surface finish.

**Brinell** is suitable for inhomogeneous metals and metals containing coarse structural elements, as for example castings and forgings. Limited to larger specimens due to high loads and indenters used – in particular cast irons, steel and aluminium.

**Rockwell** can be used for most materials but typically only for larger sized specimens due to the high loads and the indenters used.

For more details see “About hardness testing” on Struers home page [www.struers.com/en/Knowledge/Hardness-testing](http://www.struers.com/en/Knowledge/Hardness-testing)

## 8. Summary

Hardness testing is a useful tool for evaluation of materials, quality control of manufacturing processes and in research and development work. The hardness testing technique used must be selected according to the application. The preparation level must be selected according to material properties and test load.

Trials have shown that there is no significant influence of mounting resin at least up to 30 kgf for Vickers hardness testing, neither if the specimen is placed directly on the anvil nor if it is placed in a fixture. The lower the loads, the finer the surface preparation needs to be. One should take into account that softer materials (less than approximately 120 HV) are more prone to preparation artefacts.





**Struers ApS**  
Pederstrupvej 84  
DK-2750 Ballerup, Denmark  
Phone +45 44 600 800  
Fax +45 44 600 801  
struers@struers.dk  
www.struers.com

## Application Note

Hardness Testing and Specimen Preparation  
Maria Lindegren, Struers ApS

## Acknowledgements

Welding example, Figure 20 and Table 4:  
courtesy Institut de Soudure, France

Peter Bucan, Struers ApS  
Jean-Marie Boccalini, Struers S.A.S., France

## Bibliography

1. Tabor, D; "The Hardness of Metals", Oxford University Press, 2007
2. Vander Voort, Georg F., "Metallography Principles and Practice", ASM International, 1999
3. Palmqvist, S: "Method for determining the toughness of brittle materials, particularly sintered carbides", Jernkontorets annaler, volume 141, 1957
4. ASM International, volume 8
5. Rockwell: Applicable Standards: ASTM E18 / ISO 6508 / JIS Z 2245
6. Brinell: Applicable Standards: ASTM E10 / ISO 6506 / JIS Z 2243
7. Vickers: Applicable Standards  
ASTM E384 – micro force ranges – 10g to 1kg  
ASTM E92 – micro force ranges - 1kg to 100kg  
ISO 6507 – micro and macro ranges  
JIS Z 2244
8. Knoop: Applicable Standards: ASTM E384 / ISO 4545 / JIS Z 2251
9. Kay Geels, "Metallographic and Materialographic specimen preparation, light microscopy, image analysis and hardness testing", ASTM International, 2006

## Glossary

Other older denotations for Vickers hardness testing are VHN (Vickers Hardness Number) and DPN (Diamond-Pyramide hardness Number).

Knoop; an older denotation is KHN (Knoop Hardness Number).

### AUSTRALIA & NEW ZEALAND

**Struers Australia**  
27 Mayneview Street  
Milton QLD 4064  
Australia  
Phone +61 7 3512 9600  
Fax +61 7 3369 8200  
info.au@struers.dk

### BELGIQUE (Wallonie)

**Struers S.A.S.**  
370, rue du Marché Rollay  
F- 94507 Champigny  
sur Marne Cedex  
Téléphone +33 1 5509 1430  
Télécopie +33 1 5509 1449  
struers@struers.fr

### BELGIUM (Flanders)

**Struers GmbH Nederland**  
Zomerdijk 34 A  
3143 CT Maassluis  
Telefoon +31 (10) 599 7209  
Fax +31 (10) 5997201  
netherlands@struers.de

### CANADA

**Struers Ltd.**  
7275 West Credit Avenue  
Mississauga, Ontario L5N 5M9  
Phone +1 905-814-8855  
Fax +1 905-814-1440  
info@struers.com

### CHINA

**Struers Ltd.**  
No. 1696 Zhang Heng Road  
Zhang Jiang Hi-Tech Park  
Shanghai 201203, P.R. China  
Phone +86 (21) 6035 3900  
Fax +86 (21) 6035 3999  
struers@struers.cn

### CZECH REPUBLIC & SLOVAKIA

**Struers GmbH Organizační složka**  
védeckotechnický park  
Přílepská 1920,  
CZ-252 63 Roztoky u Prahy  
Phone +420 233 312 625  
Fax +420 233 312 640  
czechrepublic@struers.de  
slovakia@struers.de

### DEUTSCHLAND

**Struers GmbH**  
Carl-Friedrich-Benz-Straße 5  
D-47877 Willich  
Telefon +49 (0) 2154 486-0  
Fax +49 (0) 2154 486-222  
verkauf@struers.de

### FRANCE

**Struers S.A.S.**  
370, rue du Marché Rollay  
F-94507 Champigny  
sur Marne Cedex  
Téléphone +33 1 5509 1430  
Télécopie +33 1 5509 1449  
struers@struers.fr

### HUNGARY

**Struers GmbH**  
Magyarország Fióktelep  
Tatai ut 53  
2821 Gyermely  
Phone +36 (34) 880546  
Fax +36 (34) 880547  
hungary@struers.de

### IRELAND

**Struers Ltd.**  
Unit 11 Evolution@ AMP  
Whittle Way, Catcliffe  
Rotherham S60 5BL  
Tel. +44 0845 604 6664  
Fax +44 0845 604 6651  
info@struers.co.uk

### ITALY

**Struers Italia**  
Via Monte Grappa 80/4  
20020 Arese (MI)  
Tel. +39-02/38236281  
Fax +39-02/38236274  
struers.it@struers.it

### JAPAN

**Marumoto Struers K.K.**  
Takara 3rd Building  
18-6, Higashi Ueno 1-chome  
Taito-ku, Tokyo 110-0015  
Phone +81 3 5688 2914  
Fax +81 3 5688 2927  
struers@struers.co.jp

### NETHERLANDS

**Struers GmbH Nederland**  
Zomerdijk 34 A  
3143 CT Maassluis  
Telefoon +31 (10) 599 7209  
Fax +31 (10) 5997201  
netherlands@struers.de

### NORWAY

**Struers ApS, Norge**  
Sjoskogenveien 44C  
1407 Vinterbro  
Telefon +47 970 94 285  
info@struers.no

### ÖSTERREICH

**Struers GmbH**  
Zweigniederlassung Österreich  
Betriebsgebiet Puch Nord 8  
5412 Puch  
Telefon +43 6245 70567  
Fax +43 6245 70567-78  
austria@struers.de

### POLAND

**Struers Sp. z o.o.**  
Oddział w Polsce  
ul. Jasnogórska 44  
31-358 Kraków  
Phone +48 12 661 20 60  
Fax +48 12 626 01 46  
poland@struers.de

### ROMANIA

**Struers GmbH, Sucursala Bucuresti**  
Str. Preciziei nr. 6R  
062203 sector 6, Bucuresti  
Phone +40 (31) 101 9548  
Fax +40 (31) 101 9549  
romania@struers.de

### SCHWEIZ

**Struers GmbH**  
Zweigniederlassung Schweiz  
Weissenbrunnstraße 41  
CH-8903 Birrnsdorf  
Telefon +41 44 777 63 07  
Fax +41 44 777 63 09  
switzerland@struers.de

### SINGAPORE

**Struers Singapore**  
627A Aljunied Road,  
#07-08 BizTech Centre  
Singapore 389842  
Phone +65 6299 2268  
Fax +65 6299 2661  
struers.sg@struers.dk

### SPAIN

**Struers España**  
Camino Cerro de los Gamos 1  
Building 1 - Pozuelo de Alarcón  
CP 28224 Madrid  
Teléfono +34 917 901 204  
Fax +34 917 901 112  
struers.es@struers.es

### SUOMI

**Struers ApS, Suomi**  
Hietalahdenranta 13  
00180 Helsinki  
Puhelin +358 (0)207 919 430  
Faksi +358 (0)207 919 431  
finland@struers.fi

### SWEDEN

**Struers Sverige**  
Box 20038  
161 02 Bromma  
Telefon +46 (0)8 447 53 90  
Telefax +46 (0)8 447 53 99  
info@struers.se

### UNITED KINGDOM

**Struers Ltd.**  
Unit 11 Evolution @ AMP  
Whittle Way, Catcliffe  
Rotherham S60 5BL  
Tel. +44 0845 604 6664  
Fax +44 0845 604 6651  
info@struers.co.uk

### USA

**Struers Inc.**  
24766 Detroit Road  
Westlake, OH 44145-1598  
Phone +1 440 871 0071  
Fax +1 440 871 8188  
info@struers.com